

AGRIMATE BRUSH CUTTER

AM-243-BC-2S-PRO

AM-243-BC-2S-NEO



TECHNICAL SPECIFICATIONS

MODEL	AM-243-BC-2S-PRO/ AM-243-BC-2S-NEO
STROKE	2-STROKE
ENGINE	SINGLE CYLINDER AIR COOL ENGINE
TYPE	40-5H
DISPLACEMENT	42.7CC
ENGINE POWER	1.4KW/7000RPM
FUEL TANK CAPACITY	1150ML
FUEU MIXING RATIO FUEUMIX RATIO	1 :25-1 :35

TRANSMISSION DIAGRAM & SPARE PART LIST

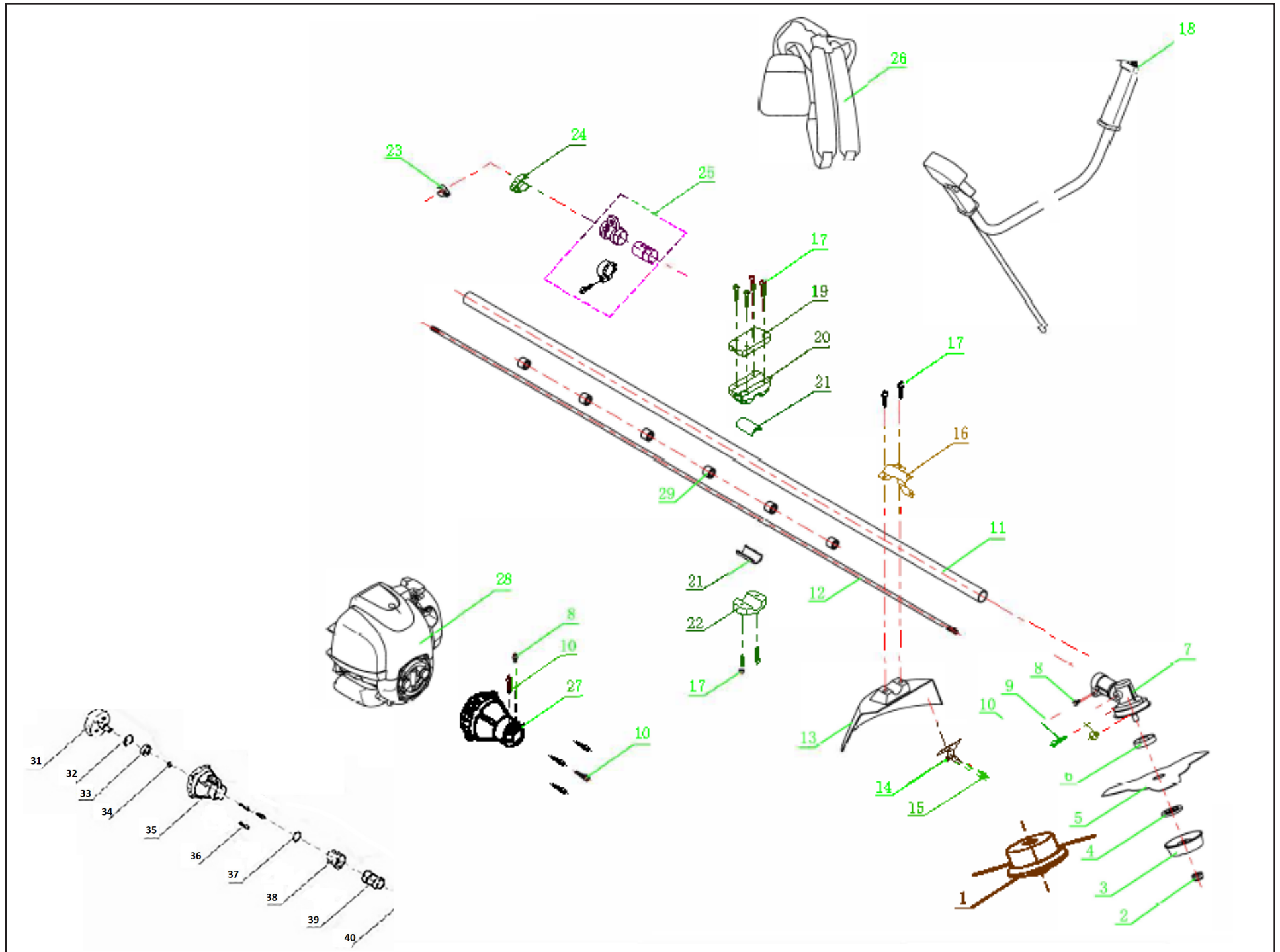

TRANSMISSION DIAGRAM & SPARE PART LIST

SL NO	PART NO	DESCRIPTION	SL NO	PART NO	DESCRIPTION
1	AM-243-BC-T01	Trimmer head	17	AM-243-BC-T17	Combined screw
2	AM-243-BC-T02	Lock nut	18	AM-243-BC-T18	Switch handle
3	AM-243-BC-T03	Blade sheild	19	AM-243-BC-T19	Upper handle base
4	AM-243-BC-T04	Press plate	20	AM-243-BC-T20	Middle handle base
5	AM-243-BC-T05	2T Blade	21	AM-243-BC-T21	Vibration reduce rubber
6	AM-243-BC-T06	Lock Plate	22	AM-243-BC-T22	Down handle base
7	AM-243-BC-T07	Gear box	23	AM-243-BC-T23	Cable locker
8	AM-243-BC-T08	Combined screw	24	AM-243-BC-T24	Cable locker
9	AM-243-BC-T09	Road head screw	25	AM-243-BC-T25	Belt mountings
10	AM-243-BC-T10	Combined screw	26	AM-243-BC-T26	Belt
11	AM-243-BC-T11	Shaft	27	AM-243-BC-T27	Clutch housing
12	AM-243-BC-T12	Nine Teeth shaft	28	AM-243-BC-T28	Engine
13	AM-243-BC-T13	Grass gurad	29	AM-243-BC-T29	Oil bearing
14	AM-243-BC-T14	cicular Blade	30	AM-243-BC-T30	NA
15	AM-243-BC-T15	Screw	31	AM-243-BC-T31	Bead Flange
16	AM-243-BC-T16	Press plate	32	AM-243-BC-T32	Rolling bearing

ENGINE DIAGRAM & SPARE PARTS LIST

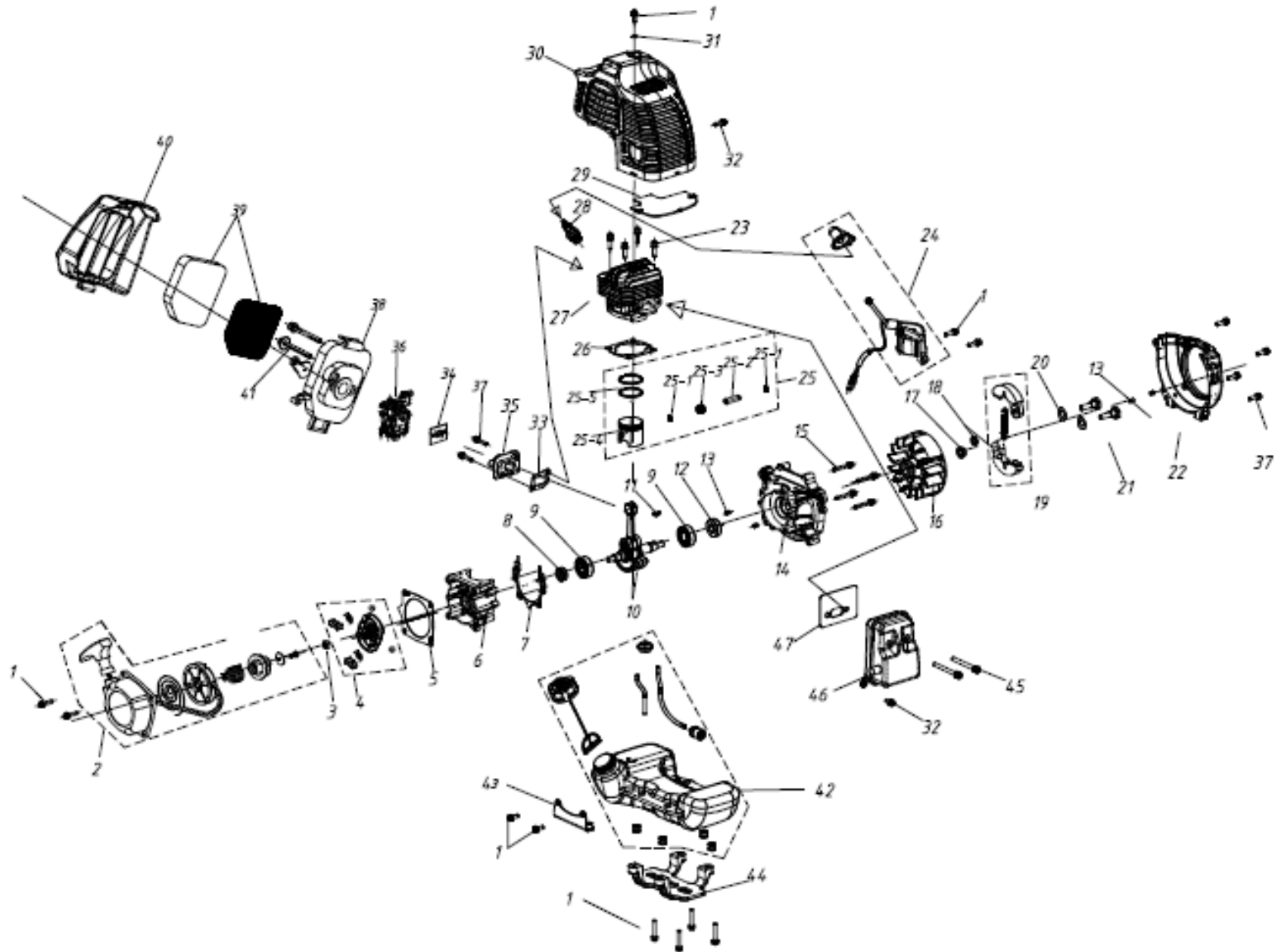

ENGINE DIAGRAM & SPARE PARTS LIST

SL NO	PART NO	DESCRIPTION	SL NO	PART NO	DESCRIPTION
1	AM-243-BC-E01	Screw	17	AM-243-BC-E17	Nut
2	AM-243-BC-E02	Combination starter	18	AM-243-BC-E18	Washer
3	AM-243-BC-E03	Nut	19	AM-243-BC-E19	Tensioning blocks
4	AM-243-BC-E04	Dial Combination	20	AM-243-BC-E20	Corrugated gasket
5	AM-243-BC-E05	Starter pad	21	AM-243-BC-E21	Screw shaft
6	AM-243-BC-E06	The second half of the crankcase	22	AM-243-BC-E22	Magnet motor shell
7	AM-243-BC-E07	crankcase Gasket	23	AM-243-BC-E23	Screw
8	AM-243-BC-E08	Oil seal	24	AM-243-BC-E24	Ignition devise
9	AM-243-BC-E09	Bearing	25	AM-243-BC-E25	Combined piston
10	AM-243-BC-E10	The crankshaft connecting rod shaft	25.1	AM-243-BC-E25.1	The piston pin circlip
11	AM-243-BC-E11	Wood ruff key	25.2	AM-243-BC-E25.2	Piston pin
12	AM-243-BC-E12	Oil seal	25.3	AM-243-BC-E25.3	Bearing
13	AM-243-BC-E13	Pin	25.4	AM-243-BC-E25.4	Piston
14	AM-243-BC-E14	The first half of the crankcase	25.5	AM-243-BC-E25.5	Piston ring group
15	AM-243-BC-E15	Screw	26	AM-243-BC-E26	Cylinder pad
16	AM-243-BC-E16	Magnet motor rotor	27	AM-243-BC-E27	Cylinder

ENGINE DIAGRAM & SPARE PARTS LIST

SL NO	PART NO	DESCRIPTION	SL NO	PART NO	DESCRIPTION
28	AM-243-BC-E28	Spark plug	44	AM-243-BC-E44	The Fuel Tank Bracket
29	AM-243-BC-E29	under the diphragm	45	AM-243-BC-E45	Screw
30	AM-243-BC-E30	Cylinder cover	46	AM-243-BC-E46	Muffler Assembly
31	AM-243-BC-E31	Insulation pad	47	AM-243-BC-E47	Silncer pad
32	AM-243-BC-E32	Screw			
33	AM-243-BC-E33	Intake pipe gasket			
34	AM-243-BC-E34	Carburetor gasket			
35	AM-243-BC-E35	Intake pipe			
36	AM-243-BC-E36	Carburetor combination			
37	AM-243-BC-E37	Screw			
38	AM-243-BC-E38	Air filter Assy			
39	AM-243-BC-E39				
40	AM-243-BC-E40				
41	AM-243-BC-E41	Screw			
42	AM-243-BC-E42	Fuel Tank Assembly			
43	AM-243-BC-E43	Tank rack			

INSPECTION & MAINTAINANCE

For safety use, make sure the machine is cleaned every three months. Before working, make sure to inspect the filter and the nozzle and ensure there is no impurity. After working, make sure there is no water in the pump and the hose.

If the machine needs to be repaired in the guarantee period, please return the machine to the shop. You need to provide the certificate of purchase on order to repair or get the substitute.

Before packing, the machine should be cleaned, then use closed packaging, packaging should be firm. Store the machine in dry place.

For transportation safety. The machine should comply with ISTA.





Do not dispose of electrical machines as unsorted municipal waste, use separate collection facilities.

If electrical machines are disposed of in landfills or dumps, hazardous substances can leak into the ground water and get into the food chain, damaging your health and well being.

When replacing old machines with new ones, the retailer is legally obligated to take back your old machine for disposals at least free of charge.





WARRANTY CARD

CUSTOMER COPY

DATE _____	DATE OF DELIVERY _____	DEALERS OFFICIAL SEAL	DEALERS SIGN _____
PURCHASERS NAME & ADDRESS _____ _____	 CUSTOMER SIGN		
PRODUCT NAME	PRODUCT SERIAL NO.	INVOICE/DN NO.	
			

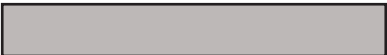



I/Will accept the terms and conditions of warranty as in the warranty card

DEALERS COPY

DATE _____	DATE OF DELIVERY _____	DEALERS OFFICIAL SEAL	DEALERS SIGN _____
PURCHASERS NAME & ADDRESS _____ _____	 CUSTOMER SIGN		
PRODUCT NAME	PRODUCT SERIAL NO.	INVOICE/DN NO.	
			

I/Will accept the terms and conditions of warranty as in the warranty card

COMPANY COPY

DATE _____	DATE OF DELIVERY _____	DEALERS OFFICIAL SEAL	DEALERS SIGN _____
PURCHASERS NAME & ADDRESS _____ _____	 CUSTOMER SIGN		
PRODUCT NAME	PRODUCT SERIAL NO.	INVOICE/DN NO.	
			

I/Will accept the terms and conditions of warranty as in the warranty card

1. LIMITED WARRANTY PERIOD : For a period of six months from the date of Sale / delivery of the product which ever is earlier. 2. LIMITED WARRANTY OBLIGATION : Replacement of defective part(s) by authorized dealer are free of charges. If found defective by reasons of defective material / poor workmanship, parts will be replaced and there will be no value re-imburement. 3. TERMS & CONDITIONS : a. Claims under warranty will be accepted on submission of Warranty Card duly filled and stamped by authorized dealer together with the original purchase document. : b. Shipping / transportation / Incidental charges incurred in replacing defective parts under warranty shall be borne by the purchaser

WARRANTY null & void if

- (i) Lack of maintenance, (ii) Incorrect use of the machine or tampering, (iii) Use of non-genuine spare parts, (iv) Usage of acids, solvents, or any flammable materials, (v) Non-usage of filter water / clear water / soft water & using water above 40°C temperature, (vi) While using the pressure washers to draw water which is contaminated with dust & solvents (eg. paint thinners, gasoline, oil, etc.), (vii) Repair done by unauthorized service people, (viii) Those parts subject to wear & tear due to normal operations and plastic parts, rubber items etc, (ix) Loose connections, faulty electrical fixtures & fluctuations in power supply.
- 4. Should any failure occur during or after the warranty period, customer does not have the right to interrupt payment / price discount.
- 5. Incidental or consequential damages like inconvenience commercial loss, loss of tie, mental agony etc.
- 6. Loss of any nature due to operation or non-operation is not covered under warranty.
- 7. All free service are at Dealer's service point only.
- 8. Warranty ceases if service is not done periodically.
- 9. The attached card should be completed and returned to Ratnagiri Impex Pvt. Ltd. for registration immediately after sale / delivery.
- 10. The warranty is void unless you register the warranty card with Ratnagiri Impex Pvt. Ltd.
- 11. The decision of Ratnagiri Impex Pvt. Ltd., in settling the warranty is final in all respects.
- 12. All disputes are subject to Bangalore Courts Jurisdiction

1. LIMITED WARRANTY PERIOD : For a period of six months from the date of Sale / delivery of the product which ever is earlier. 2. LIMITED WARRANTY OBLIGATION : Replacement of defective part(s) by authorized dealer are free of charges. If found defective by reasons of defective material / poor workmanship, parts will be replaced and there will be no value re-imburement. 3. TERMS & CONDITIONS : a. Claims under warranty will be accepted on submission of Warranty Card duly filled and stamped by authorized dealer together with the original purchase document. : b. Shipping / transportation / Incidental charges incurred in replacing defective parts under warranty shall be borne by the purchaser.

WARRANTY null & void if

- (i) Lack of maintenance, (ii) Incorrect use of the machine or tampering, (iii) Use of non-genuine spare parts, (iv) Usage of acids, solvents, or any flammable materials, (v) Non-usage of filter water / clear water / soft water & using water above 40°C temperature, (vi) While using the pressure washers to draw water which is contaminated with dust & solvents (eg. paint thinners, gasoline, oil, etc.), (vii) Repair done by unauthorized service people, (viii) Those parts subject to wear & tear due to normal operations and plastic parts, rubber items etc, (ix) Loose connections, faulty electrical fixtures & fluctuations in power supply.
- 4. Should any failure occur during or after the warranty period, customer does not have the right to interrupt payment / price discount.
- 5. Incidental or consequential damages like inconvenience commercial loss, loss of tie, mental agony etc.
- 6. Loss of any nature due to operation or non-operation is not covered under warranty.
- 7. All free service are at Dealer's service point only.
- 8. Warranty ceases if service is not done periodically.
- 9. The attached card should be completed and returned to Ratnagiri Impex Pvt. Ltd. for registration immediately after sale / delivery.
- 10. The warranty is void unless you register the warranty card with Ratnagiri Impex Pvt. Ltd.
- 11. The decision of Ratnagiri Impex Pvt. Ltd., in settling the warranty is final in all respects.
- 12. All disputes are subject to Bangalore Courts Jurisdiction

1. LIMITED WARRANTY PERIOD : For a period of six months from the date of Sale / delivery of the product which ever is earlier. 2. LIMITED WARRANTY OBLIGATION : Replacement of defective part(s) by authorized dealer are free of charges. If found defective by reasons of defective material / poor workmanship, parts will be replaced and there will be no value re-imburement. 3. TERMS & CONDITIONS : a. Claims under warranty will be accepted on submission of Warranty Card duly filled and stamped by authorized dealer together with the original purchase document. : b. Shipping / transportation / Incidental charges incurred in replacing defective parts under warranty shall be borne by the purchaser.

WARRANTY null & void if

- (i) Lack of maintenance, (ii) Incorrect use of the machine or tampering, (iii) Use of non-genuine spare parts, (iv) Usage of acids, solvents, or any flammable materials, (v) Non-usage of filter water / clear water / soft water & using water above 40°C temperature, (vi) While using the pressure washers to draw water which is contaminated with dust & solvents (eg. paint thinners, gasoline, oil, etc.), (vii) Repair done by unauthorized service people, (viii) Those parts subject to wear & tear due to normal operations and plastic parts, rubber items etc, (ix) Loose connections, faulty electrical fixtures & fluctuations in power supply.
- 4. Should any failure occur during or after the warranty period, customer does not have the right to interrupt payment / price discount.
- 5. Incidental or consequential damages like inconvenience commercial loss, loss of tie, mental agony etc.
- 6. Loss of any nature due to operation or non-operation is not covered under warranty.
- 7. All free service are at Dealer's service point only.
- 8. Warranty ceases if service is not done periodically.
- 9. The attached card should be completed and returned to Ratnagiri Impex Pvt. Ltd. for registration immediately after sale / delivery.
- 10. The warranty is void unless you register the warranty card with Ratnagiri Impex Pvt. Ltd.
- 11. The decision of Ratnagiri Impex Pvt. Ltd., in settling the warranty is final in all respects.
- 12. All disputes are subject to Bangalore Courts Jurisdiction



FREE SERVICE COUPON (30DAYS/30HRS. WHICHEVER IS EARLIER)

MODEL

SERIAL NUMBER

PDI DATE

SERVICE NO.

PURCHASE BILL NO.

DATE

DEALERS OFFICE SEAL

- 1. Check and test the fuel mixture
- 3. Check , clean and adjust the spark plug
- 5. Check and sparken the cutting tools
- 7. Start and check the noise, vibration, loosen etc..

OPERATIONS

- 2. check and clean the air filter
- 4. Check and adjust the carburetor tuning
- 6. Product familirisation on usage
- 8. Routine maintenance and shortage.

FREE SERVICE COUPON (30DAYS/30HRS. WHICHEVER IS EARLIER)

MODEL

SERIAL NUMBER

PDI DATE

SERVICE NO.

PURCHASE BILL NO.

DATE

DEALERS OFFICE SEAL

- 1. Check and test the fuel mixture
- 3. Check , clean and adjust the spark plug
- 5. Check and sparken the cutting tools
- 7. Start and check the noise, vibration, loosen etc..

OPERATIONS

- 2. check and clean the air filter
- 4. Check and adjust the carburetor tuning
- 6. Product familirisation on usage
- 8. Routine maintenance and shortage.

FREE SERVICE COUPON (30DAYS/30HRS. WHICHEVER IS EARLIER)

MODEL

SERIAL NUMBER

PDI DATE

SERVICE NO.

PURCHASE BILL NO.

DATE

DEALERS OFFICE SEAL

- 1. Check and test the fuel mixture
- 3. Check , clean and adjust the spark plug
- 5. Check and sparken the cutting tools
- 7. Start and check the noise, vibration, loosen etc..

OPERATIONS

- 2. check and clean the air filter
- 4. Check and adjust the carburetor tuning
- 6. Product familirisation on usage
- 8. Routine maintenance and shortage.

DOS

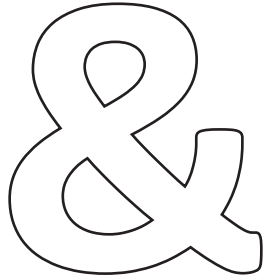

DONT'S

1. Always read the instruction manual supplied along with the equipments and understand the correct installation and operating procedures before attempting to use the equipments.
2. It is important to use the personal protection equipments such as head helmet with visor, ear defenders, goggles, safety gloves, cut resistant shoes, trousers and jackets while operating potentially dangerous machines
3. Avoid untrained persons using the equipments. Children must not be allowed to handle these equipments
4. Always use genuine spares and accessories in repairs and usage to derive maximum life of the equipments.
5. Always keep the equipments in good working condition to minimize loss of output as well as to reduce the pollution and save the environment
6. Do not use the machine within range of persons unless they wear protective clothing
7. Do not operate the machine when fatigued or under the influence of alcohol or drugs
8. When the machine is running, please maintain a constant water supply. Without water circulation will damage the sealing rings of the machine.
9. For more query kindly contact for our Service Center/Dealer/ franchise

AGRIMATE MULTI PURPOSE EQUIPMENT ANYWHERE - ANYTIME - ANY CROP

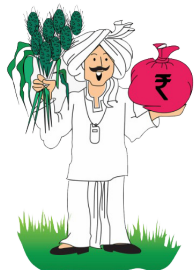

 **ratnagiri®
impeX**
BRINGING YOU THE FUTURE... NOW

IMPORTED & MARKETING BY,
RATNAGIRI IMPEX PVT., LTD.,
Annapurna House, #1 / 1G, 7th Cross, New
Guddadahalli Mysore Road, Bangalore - 560 026
Missed Call : 7393 938 938 Email: ask@agrimart.in