

AGRIMATE BRUSH CUTTER - PUSH TYPE

AM-5300PT-2S-NEO



INTRODUCTION

Dear Sir/ Madam,

Thank you for choosing Agrimate product. You are the proud owner of high technology & durable machine. Trust that our Franchisee/Dealer installed the product & explained you about the usage & service instructions. Please visit our authorised dealer for your future requirement of our other equipments, genuine spares, accessories and services. Service coupons are attached with this manual and you can avail free service to keep your machine fit always to use on demand.

About Ratnagiri,

We import and market of high quality of agriculture wide range of equipments which we are selling through our authorised franchisee or dealer network. We are in this field from past years service the farmer. community. For further details, Please visit our website www.agrimart.in. & Give a missed call to **7393 938 938**

TECHNICAL SPECIFICATIONS

MODEL	AM-5300PT-2S-PRO
ENGINE TYPE	2S , AIRCOOLED
TYPE OF HANDLE	DOUBLE GRIP
DISPLACEMENT	42.7CC
METHOD OF STARTING	RECOIL STARTING
FUEL TANK CAPACITY	1.2L



This graphic accompanied by the words **WARNING** and **DANGER**
Calls attention to an act or a condition which can lead to **SERIOUS**
INJURY

READ & UNDERSTAND Operator's Manual and Safety Manual.

ALWAYS WEAR EYE AND EAR PROTECTION.

Always **TURN OFF ENGINE** and make sure the cutting tool has
stopped before cleaning, removing or adjusting blade.

WARNING! Never modify a trimmer or cutter in any way.
Improper use of any trimmer can cause **SERIOUS OR**
FATAL PERSONAL INJURY.

The engine exhaust from this product contains chemicals to cause cancer,
birth defects, or other reproductive harm.

Proper safety precautions must be observed. Like all equipment this unit must be handled carefully

DO NOT EXPOSE YOURSELF TO DANGER. Follow these general rules. Do not permit others to use this machine unless they are thoroughly responsible and have read and understand the machine manual and are trained in its operation.

- Always wear safety goggles for eye protection. Dress properly, do not wear loose clothing or jewelry that could become caught in moving parts of the unit. Safe, sturdy, nonskid footwear should always be worn. Long hair should be tied back. It is recommended that legs and feet be covered to protect from flying debris during operation.
- Inspect the entire machine for loose parts (nuts, bolts, screws, etc.) and any damage. Repair or replace as necessary before using the machine.
- Do not use any attachment with this power head other than the ones recommended by our company. Serious Injury to the operator or bystanders could result as well as damage to the machine.
- Keep the handles free from oil and fuel.
- Always use proper handle and shoulder strap when cutting.
- Do not smoke while mixing fuel or filling tank.
- Do not mix fuel in an enclosed room or near open flames. Assure adequate ventilation.
- Always mix and store the fuel in a properly marked container that is approved by local codes and ordinances for such usage.
- Never remove the fuel tank cap while the engine is running.
- Never start or run the engine inside a closed room or building. Fumes from the exhaust contain dangerous carbon monoxide.
- Never attempt to make engine adjustments while the unit is running and strapped to the operator. Always make engine adjustments with the unit resting on a flat, clear surface.
- Do not use the unit if it is damaged or poorly adjusted. Never remove the machine's guard.
- Inspect the area to be cut and remove all debris that could become entangled in the nylon cutting head. Also remove any objects that the unit is resting on a flat, clear surface.
- Keep Children away. Onlookers should be kept at a safe distance from the work area, at least 50 FEET.
- Never leave the machine unattended.
- Do not use this unit for any job other than those for which it is intended as described in this manual.
- Do not overreach. Keep proper footing and balance at all times. Do not run the unit while standing on a ladder or any other unstable footing location.
- Keep hands and feet clear of the nylon cutting head while unit is in use.
- Do not use this type of machine for sweeping away debris.
- Do not use the unit when you are tired or under the influence of medication, drugs or alcohol.
- Use nylon cutting head which is free of damage. If a stone or any other obstacle is hit, stop the engine and check the nylon cutting head. A broken or unbalanced nylon cutting head must never be used.

FOLLOW INSTRUCTION FOR CHANGING ACCESSORIES.

- Do not store in a closed area where fuel vapors can reach an open flame from hot water heaters, furnaces, etc. store in a locked, well-ventilated area only.
- Use only our company original equipment parts when servicing the unit, this will ensure safe and proper performance of your product. These parts are available from your dealer. The use of any other accessories or attachments may cause a potential hazard or the user, damage to the machine and void this warranty.
- Clean the machine completely, especially the fuel tank, its surroundings, and the air cleaner.
- When refueling be sure to stop the engine and confirm that it cooled down. Never refuel when the engine is running or hot. When gasoline spills, be sure to wipe it up completely and properly dispose of those materials before starting the engine.
- Stay clear of other workers or bystanders by at least 15 meters/50 feet.
- When ever approaching an operator of the machine, carefully call his attention and confirm that the operator stops the engine. Be careful not to startle or distract the operator which can cause an unsafe situation.
- Never touch the nylon cutting head when ever the engine is running. If it is necessary to adjust the protector or nylon cutting head, be sure to stop the engine and confirm that the nylon cutting head has stopped running.
- The engine should be turned off when the machine is moved between work area.
- Be careful not to hit the nylon cutting head against stones, or the ground. Unreasonable rough operation will shorten the life of the machine as well as create an unsafe environment for yourself and those around you.
- Pay attention to loosening and overheating of the parts. If there is any abnormality of the machine, stop operation immediately and check the machine carefully. If necessary, have the machine serviced by an authorized dealer. Never continue to operate a machine which may be malfunctioning.
- In start- up or during operation of the engine, never touch hot parts such as the muffler, the high voltage wire or the spark plug.
- After the engine has stopped, the muffler is still hot. Never place the machine in any places where there are flammable materials (dry grass, etc.), combustible gasses or combustible liquids.
- Pay special attention to operation in the rain or just after the rain as the ground may be slippery.
- If you slip or fall to the ground or into a hole, release the throttle lever immediately.
- Be careful not to drop the machine or hit it against obstacles.
- Before proceeding to adjust or repair the machine, be sure to stop the engine and detach the spark plug cap from the spark plug.
- When the machine is placed in storage for a long time, drain fuel from the fuel tank and carburetor, clean the parts, move the machine to a safe place and confirm that the engine is cooled down.
- Make periodic inspections to assure safe and efficient operation. For a thorough inspection of your machine, please contact a dealer.
- Keep the machine away from fire or sparks.
- **WARNING:** The cutter area is still dangerous while the machine is coasting to a stop.

TRANSMISSION DIAGRAM & SPARE PARTS LIST OF AM-5300PT-2S BRUSH CUTTER - PUSH TYPE

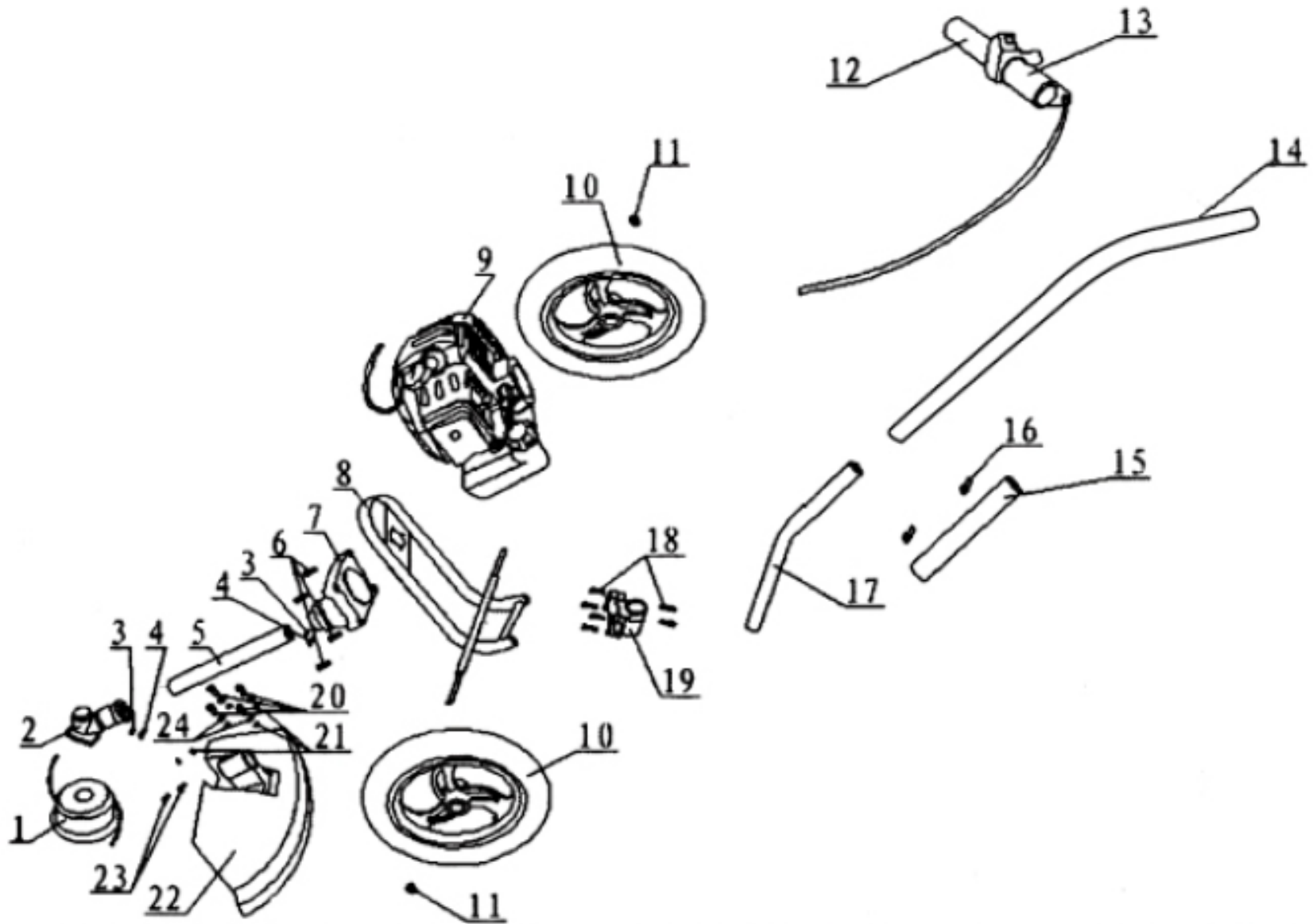

TRANSMISSION DIAGRAM & SPARE PARTS LIST OF AM-5300PT-2S BRUSH CUTTER - PUSH TYPE

SL NO	PART NO	DESCRIPTION	SL NO	PART NO	DESCRIPTION
1	AM-5300PT-TA01	Nylon Head	13	AM-5300PT-TA13	Throttle Switch
2	AM-5300PT-TA02	Corner Jet	14	AM-5300PT-TA14	Handle Bar
3	AM-5300PT-TA03	Hexagon screw combination	15	AM-5300PT-TA15	handle Connection Cover
4	AM-5300PT-TA04	Hexagon screw combination	16	AM-5300PT-TA16	Handle connection cover button
5	AM-5300PT-TA05	Transfer Rod	17	AM-5300PT-TA17	Handle Connection Bar
6	AM-5300PT-TA06	Hexagon screw combination	18	AM-5300PT-TA18	Hexagon screw combination
7	AM-5300PT-TA07	Transmission connection seat	19	AM-5300PT-TA19	Handle connection Seat
8	AM-5300PT-TA08	Holder	20	AM-5300PT-TA20	Hexagon screw combination
9	AM-5300PT-TA09	Engine	21	AM-5300PT-TA21	Lock nut
10	AM-5300PT-TA10	Wheel	22	AM-5300PT-TA22	Grass Fender
11	AM-5300PT-TA11	Lock nut	23	AM-5300PT-TA23	Hexagon screw combination
12	AM-5300PT-TA12	Rubber handle	24	AM-5300PT-TA24	Flat Gasket

ENGINE DIAGRAM & SPARE PARTS LIST OF AM-5300PT-2S BRUSH CUTTER - PUSH TYPE

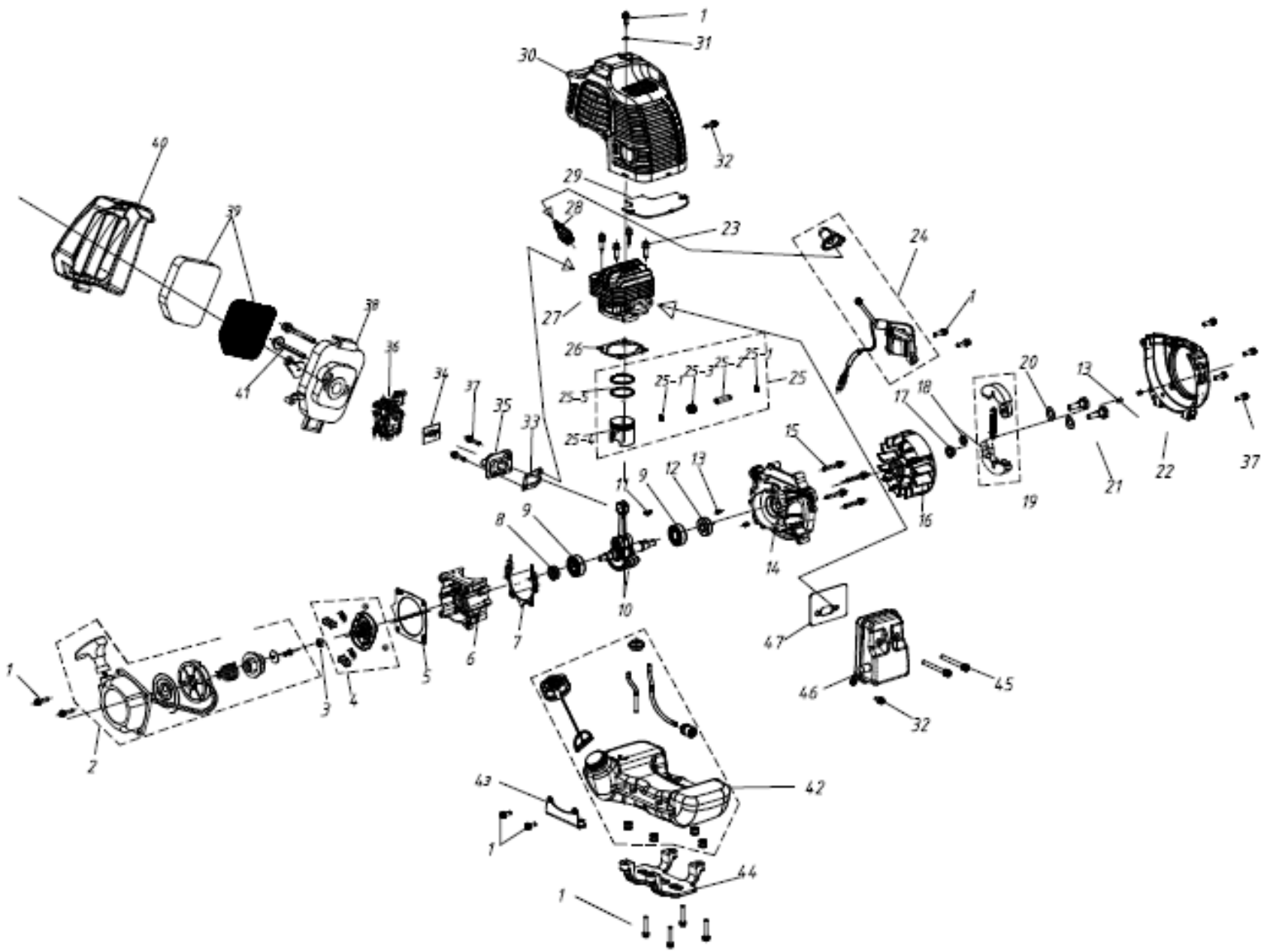

ENGINE DIAGRAM & SPARE PARTS LIST OF AM-5300PT-2S BRUSH CUTTER - PUSH TYPE

SL NO	PART NO	DESCRIPTION	SL NO	PART NO	DESCRIPTION
1	AM-5300PT-EA01	Air filter cover bolt	17	AM-5300PT-EA17	Bolt
2	AM-5300PT-EA02	Air filter cover	18	AM-5300PT-EA18	Cylinder Gasket
3	AM-5300PT-EA03	Choke sticker	19	AM-5300PT-EA19	Cylinder Bolt
4	AM-5300PT-EA04	Fliter Element	20	AM-5300PT-EA20	Cylinder
5	AM-5300PT-EA05	Air filter cover	21	AM-5300PT-EA21	Exhaust double head bolt
6	AM-5300PT-EA06	Air filter bolts	22	AM-5300PT-EA22	Muffler gasket
7	AM-5300PT-EA07	Air filter	23	AM-5300PT-EA23	Muffler
8	AM-5300PT-EA08	Carburetor	24	AM-5300PT-EA24	Nut
9	AM-5300PT-EA09	Carburetor Gasket	25	AM-5300PT-EA25	Nut
10	AM-5300PT-EA10	Intake block Bolts	26	AM-5300PT-EA26	Muffler Cover
11	AM-5300PT-EA11	Intake block	27	AM-5300PT-EA27	Bolt
12	AM-5300PT-EA12	Intake block Gasket	28	AM-5300PT-EA28	Exhaust Bolt
13	AM-5300PT-EA13	Small cap Screw	29	AM-5300PT-EA29	Exhaust valve
14	AM-5300PT-EA14	Small Cap	30	AM-5300PT-EA30	Exhaust valve Bolt
15	AM-5300PT-EA15	Plastic Cover	31	AM-5300PT-EA31	Bolt
16	AM-5300PT-EA16	Sticker	32	AM-5300PT-EA32	Puller

ENGINE DIAGRAM & SPARE PARTS LIST OF AM-5300PT-2S BRUSH CUTTER - PUSH TYPE





SL NO	PART NO	DESCRIPTION	SL NO	PART NO	DESCRIPTION
33	AM-5300PT-EA33	Starter plate	49	AM-5300PT-EA49	Fly wheel
34	AM-5300PT-EA34	Oil seal	50	AM-5300PT-EA50	Spark Plug
35	AM-5300PT-EA35	Right cylinder	51	AM-5300PT-EA51	Ignition Cap
36	AM-5300PT-EA36	Bearing	52	AM-5300PT-EA52	Ignition Coil
37	AM-5300PT-EA37	Crankshaft	53	AM-5300PT-EA53	Bolt
38	AM-5300PT-EA38	Ball point bearing	54	AM-5300PT-EA54	Rubber Bottern
39	AM-5300PT-EA39	Piston pin reed	55	AM-5300PT-EA55	Off switch cable
40	AM-5300PT-EA40	Piston pin	56	AM-5300PT-EA56	Nut
41	AM-5300PT-EA41	Piston	57	AM-5300PT-EA57	Gasket
42	AM-5300PT-EA42	Piston Ring	58	AM-5300PT-EA58	Clutch Shoe
43	AM-5300PT-EA43	Location pin	59	AM-5300PT-EA59	Gasket
44	AM-5300PT-EA44	Woodruff key	60	AM-5300PT-EA60	Stage Screw
45	AM-5300PT-EA45	Left Cylinder	61	AM-5300PT-EA61	Dowel Pin
46	AM-5300PT-EA46	Cylinder combine bolt	62	AM-5300PT-EA62	Left Cover
47	AM-5300PT-EA47	Wind sheid	63	AM-5300PT-EA63	Left Cover bolt
48	AM-5300PT-EA48	Pouches	64	AM-5300PT-EA64	Harness board

ENGINE DIAGRAM & SPARE PARTS LIST OF AM-5300PT-2S BRUSH CUTTER - PUSH TYPE

SL NO	PART NO	DESCRIPTION	SL NO	PART NO	DESCRIPTION
65	AM-5300PT-EA65	Sticker	75	AM-5300PT-EA75	Oil Feedign tube
66	AM-5300PT-EA66	Bolt	76	AM-5300PT-EA76	Oil Output tube
67	AM-5300PT-EA67	Plastic Guard board	77	AM-5300PT-EA77	Dipstick
68	AM-5300PT-EA68	Sticker	78	AM-5300PT-EA78	Single valve
69	AM-5300PT-EA69	oil Tank Cap Assy	79	AM-5300PT-EA79	Seal Gasket
70	AM-5300PT-EA70	Bolt	80	AM-5300PT-EA80	Oil Lid Cup
71	AM-5300PT-EA71	oil Tank	81	AM-5300PT-EA81	Oil Lid
72	AM-5300PT-EA72	Oil Filter			
73	AM-5300PT-EA73	Snaps			
74	AM-5300PT-EA74	Oil Plastic Cover			





WARRANTY CARD

CUSTOMER COPY

DATE _____	DATE OF DELIVERY _____	DEALERS OFFICIAL SEAL	DEALERS SIGN _____
PURCHASERS NAME & ADDRESS _____ _____	 CUSTOMER SIGN		
PRODUCT NAME	PRODUCT SERIAL NO.	INVOICE/DN NO.	
			





I/Will accept the terms and conditions of warranty as in the warranty card

DEALERS COPY

DATE _____	DATE OF DELIVERY _____	DEALERS OFFICIAL SEAL	DEALERS SIGN _____
PURCHASERS NAME & ADDRESS _____ _____	 CUSTOMER SIGN		
PRODUCT NAME	PRODUCT SERIAL NO.	INVOICE/DN NO.	
			

I/Will accept the terms and conditions of warranty as in the warranty card

COMPANY COPY

DATE _____	DATE OF DELIVERY _____	DEALERS OFFICIAL SEAL	DEALERS SIGN _____
PURCHASERS NAME & ADDRESS _____ _____	 CUSTOMER SIGN		
PRODUCT NAME	PRODUCT SERIAL NO.	INVOICE/DN NO.	
			

I/Will accept the terms and conditions of warranty as in the warranty card

1. LIMITED WARRANTY PERIOD : For a period of six months from the date of Sale / delivery of the product which ever is earlier. 2. LIMITED WARRANTY OBLIGATION : Replacement of defective part(s) by authorized dealer are free of charges. If found defective by reasons of defective material / poor workmanship, parts will be replaced and there will be no value re-imburement. 3. TERMS & CONDITIONS : a. Claims under warranty will be accepted on submission of Warranty Card duly filled and stamped by authorized dealer together with the original purchase document. : b. Shipping / transportation / Incidental charges incurred in replacing defective parts under warranty shall be borne by the purchaser

WARRANTY null & void if

- (i) Lack of maintenance, (ii) Incorrect use of the machine or tampering, (iii) Use of non-genuine spare parts, (iv) Usage of acids, solvents, or any flammable materials, (v) Non-usage of filter water / clear water / soft water & using water above 40°C temperature, (vi) While using the pressure washers to draw water which is contaminated with dust & solvents (eg. paint thinners, gasoline, oil, etc.), (vii) Repair done by unauthorized service people, (viii) Those parts subject to wear & tear due to normal operations and plastic parts, rubber items etc, (ix) Loose connections, faulty electrical fixtures & fluctuations in power supply.
- 4. Should any failure occur during or after the warranty period, customer does not have the right to interrupt payment / price discount.
- 5. Incidental or consequential damages like inconvenience commercial loss, loss of tie, mental agony etc.
- 6. Loss of any nature due to operation or non-operation is not covered under warranty.
- 7. All free service are at Dealer's service point only.
- 8. Warranty ceases if service is not done periodically.
- 9. The attached card should be completed and returned to Ratnagiri Impex Pvt. Ltd. for registration immediately after sale / delivery.
- 10. The warranty is void unless you register the warranty card with Ratnagiri Impex Pvt. Ltd.
- 11. The decision of Ratnagiri Impex Pvt. Ltd., in settling the warranty is final in all respects.
- 12. All disputes are subject to Bangalore Courts Jurisdiction

1. LIMITED WARRANTY PERIOD : For a period of six months from the date of Sale / delivery of the product which ever is earlier. 2. LIMITED WARRANTY OBLIGATION : Replacement of defective part(s) by authorized dealer are free of charges. If found defective by reasons of defective material / poor workmanship, parts will be replaced and there will be no value re-imburement. 3. TERMS & CONDITIONS : a. Claims under warranty will be accepted on submission of Warranty Card duly filled and stamped by authorized dealer together with the original purchase document. : b. Shipping / transportation / Incidental charges incurred in replacing defective parts under warranty shall be borne by the purchaser.

WARRANTY null & void if

- (i) Lack of maintenance, (ii) Incorrect use of the machine or tampering, (iii) Use of non-genuine spare parts, (iv) Usage of acids, solvents, or any flammable materials, (v) Non-usage of filter water / clear water / soft water & using water above 40°C temperature, (vi) While using the pressure washers to draw water which is contaminated with dust & solvents (eg. paint thinners, gasoline, oil, etc.), (vii) Repair done by unauthorized service people, (viii) Those parts subject to wear & tear due to normal operations and plastic parts, rubber items etc, (ix) Loose connections, faulty electrical fixtures & fluctuations in power supply.
- 4. Should any failure occur during or after the warranty period, customer does not have the right to interrupt payment / price discount.
- 5. Incidental or consequential damages like inconvenience commercial loss, loss of tie, mental agony etc.
- 6. Loss of any nature due to operation or non-operation is not covered under warranty.
- 7. All free service are at Dealer's service point only.
- 8. Warranty ceases if service is not done periodically.
- 9. The attached card should be completed and returned to Ratnagiri Impex Pvt. Ltd. for registration immediately after sale / delivery.
- 10. The warranty is void unless you register the warranty card with Ratnagiri Impex Pvt. Ltd.
- 11. The decision of Ratnagiri Impex Pvt. Ltd., in settling the warranty is final in all respects.
- 12. All disputes are subject to Bangalore Courts Jurisdiction

1. LIMITED WARRANTY PERIOD : For a period of six months from the date of Sale / delivery of the product which ever is earlier. 2. LIMITED WARRANTY OBLIGATION : Replacement of defective part(s) by authorized dealer are free of charges. If found defective by reasons of defective material / poor workmanship, parts will be replaced and there will be no value re-imburement. 3. TERMS & CONDITIONS : a. Claims under warranty will be accepted on submission of Warranty Card duly filled and stamped by authorized dealer together with the original purchase document. : b. Shipping / transportation / Incidental charges incurred in replacing defective parts under warranty shall be borne by the purchaser.

WARRANTY null & void if

- (i) Lack of maintenance, (ii) Incorrect use of the machine or tampering, (iii) Use of non-genuine spare parts, (iv) Usage of acids, solvents, or any flammable materials, (v) Non-usage of filter water / clear water / soft water & using water above 40°C temperature, (vi) While using the pressure washers to draw water which is contaminated with dust & solvents (eg. paint thinners, gasoline, oil, etc.), (vii) Repair done by unauthorized service people, (viii) Those parts subject to wear & tear due to normal operations and plastic parts, rubber items etc, (ix) Loose connections, faulty electrical fixtures & fluctuations in power supply.
- 4. Should any failure occur during or after the warranty period, customer does not have the right to interrupt payment / price discount.
- 5. Incidental or consequential damages like inconvenience commercial loss, loss of tie, mental agony etc.
- 6. Loss of any nature due to operation or non-operation is not covered under warranty.
- 7. All free service are at Dealer's service point only.
- 8. Warranty ceases if service is not done periodically.
- 9. The attached card should be completed and returned to Ratnagiri Impex Pvt. Ltd. for registration immediately after sale / delivery.
- 10. The warranty is void unless you register the warranty card with Ratnagiri Impex Pvt. Ltd.
- 11. The decision of Ratnagiri Impex Pvt. Ltd., in settling the warranty is final in all respects.
- 12. All disputes are subject to Bangalore Courts Jurisdiction



FREE SERVICE COUPON (30DAYS/30HRS. WHICHEVER IS EARLIER)

MODEL

SERIAL NUMBER

PDI DATE

SERVICE NO.

PURCHASE BILL NO.

DATE

DEALERS OFFICE SEAL

- 1. Check and test the fuel mixture
- 3. Check , clean and adjust the spark plug
- 5. Check and sparken the cutting tools
- 7. Start and check the noise, vibration, loosen etc..

OPERATIONS

- 2. check and clean the air filter
- 4. Check and adjust the carburetor tuning
- 6. Product familirisation on usage
- 8. Routine maintenance and shortage.

FREE SERVICE COUPON (30DAYS/30HRS. WHICHEVER IS EARLIER)

MODEL

SERIAL NUMBER

PDI DATE

SERVICE NO.

PURCHASE BILL NO.

DATE

DEALERS OFFICE SEAL

- 1. Check and test the fuel mixture
- 3. Check , clean and adjust the spark plug
- 5. Check and sparken the cutting tools
- 7. Start and check the noise, vibration, loosen etc..

OPERATIONS

- 2. check and clean the air filter
- 4. Check and adjust the carburetor tuning
- 6. Product familirisation on usage
- 8. Routine maintenance and shortage.

FREE SERVICE COUPON (30DAYS/30HRS. WHICHEVER IS EARLIER)

MODEL

SERIAL NUMBER

PDI DATE

SERVICE NO.

PURCHASE BILL NO.

DATE

DEALERS OFFICE SEAL

- 1. Check and test the fuel mixture
- 3. Check , clean and adjust the spark plug
- 5. Check and sparken the cutting tools
- 7. Start and check the noise, vibration, loosen etc..

OPERATIONS

- 2. check and clean the air filter
- 4. Check and adjust the carburetor tuning
- 6. Product familirisation on usage
- 8. Routine maintenance and shortage.

DOS

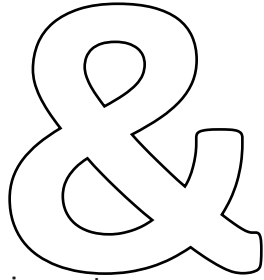

DONT'S

attempting to use the equipments.

1. Always read the instruction manual supplied along with the equipments and understand the correct installation and operating procedures before

trousers and jackets while operating potentially dangerous machines
2. It is important to use the personal protection equipments such as head helmet with visor, ear defenders, goggles, safety gloves, cut resistant shoes,
3. Avoid untrained persons using the equipments. Children must not be allowed to handle these equipments
4. Always use genuine spares and accessories in repairs and usage to derive maximum life of the equipments.
5. Always keep the equipments in good working condition to minimize loss of output as well as to reduce the pollution and save the environment
6. Do not use the machine within range of persons unless they wear protective clothing
7. Do not operate the machine when fatigued or under the influence of alcohol or drugs
8. For more query kindly contact for our Service Center/Dealer/ franchise

NO. 1 CHOICE OF FARMERS SINCE 1999



Marketed by.
**ratnagiri
impex**
BRINGING YOU THE FUTURE... NOW

RATNAGIRI IMPEX PVT., LTD.,

Annapurna House, #1 / 1G, 7th Cross, New
Guddadahalli

Mysore Road, Bangalore - 560 026

Missed Call : 7393 938 938

Email: ask@agrimart.in