

AGRIMATE EARTH AUGER WITH WHEEL
AM-6300EAW-2S-MS+



INTRODUCTION

Dear Sir/ Madam,

Thank you for choosing Agrimate product. You are the proud owner of high technology & durable machine. Trust that our Franchisee/Dealer installed the product & installed the product and explained you about the usage & service instructions. Please visit our autorised dealer for your future requirement of our other equipments, genuine spares, accessories and services. Service coupons are attached with this manual and you can avail free service to keep your machine fit always to use on demand.

About Ratnagiri,

We import and market of high quality of agriculture wide range of equipments which we are selling through our authorised franchisee or dealer network. We are in this field from past years service the farmer. community. For further details, Please visit our website www.agrimart.in. & Give a missed call to 7393 938 938.

TECHNICAL SPECIFICATIONS

MODEL	AM-6300EAW-2S-MS+
ENGINE MODEL	AM-IE44F
ENGINE TYPE	AIR COOLED 2S
DISPLACEMENT	63 cc
POWER	1.8KW/ 6500RPM
CARBURETOR	DIAPHRAM TYPE
FULE TANK CAPACITY	1.2LTR
DRILLER DIEMETER	100mm/150mm/200mm

NAME & PARTS OF THE MACHINE

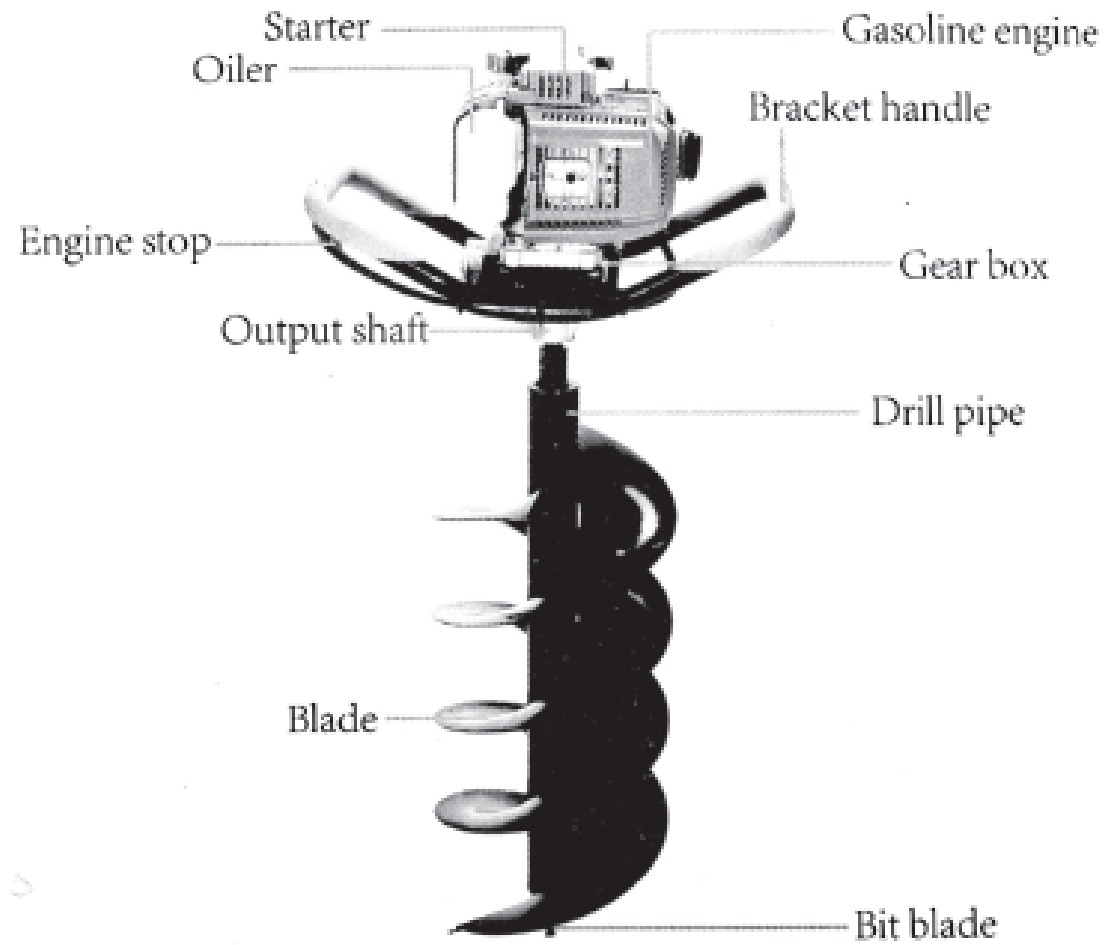

A. SAFETY RULES & PRECAUTIONS

DRESS

1. Wear a long sleeve Shirt & long pants closed
2. Do not wear a neck tie or other loosely hanging garments. Such articles may become entangled in the drill when working
3. Wear a protective goggles to protect eyes from flying objects
4. wear a work cap when working on flat ground and a helmet when working on slopes.
5. Wear Work shoes equipped with no-slip tread
6. Wear a ear plugs or other adequate device to protect the ear drum from noise.

ENVIRONMENTAL PRECAUTIONS

1. Do not work for long periods of time in summer & winter. Take breaks frequently.
2. Do not use the Earth auger in the rain. The possibility of slipping is increased when the land is wet.
3. Do not use the augers in indoors or in poorly ventilated places. Exhaust is poisonous.

Strictly No Fire - This equipment run on Gasoline

1. Do not smoke or introduce live flames in the vicinity of the auger
2. Do not remove the gas cap or refuel While the engine is running or in hot
3. Wipe the auger body dry of any spilled gasoline after refueling.
4. Ensure atleast 3m distance from fuel sources when starting the equipment up.
5. Keep flammables away from the muffler and the exhaust path .
6. store fuel in approved containers only and keep in a cool place.

CHECK BEFORE START UP

1. Check all bolts & nuts are securely tight. Tighter where necessary
2. Check the cutting blades are well filed and void of chipping, cracking or bending. Never use a drill when damaged

CAUTIONS DURING USAGES

1. Do not allow other persons within 5mtr of the worksite. It is dangerous for pets & childrens to be near the equipment when operating.
2. Use caution when drilling through rock taden ground. This equipment may rotate in reverse.
3. It is dangerous to use the auger in ackward & uncomfortable position.
4. Make sure to stop the engine before allowing persons to approach within 5 mtr. of the equipment. Make sure anyone approaching the auger approaches it from the front.
5. Always stop the engine and take the necessary cautions when suspending work or moving to other person.
6. Don not allow childerns or anyone whoc is unskilled in equipment usage, to operate the equipment.
7. Never touch the drill when the engine is running. Make sure the engine is off and the drill has stopped rotating before handling it.
8. Beaware of the drill when rotating keep your bodu away from the drill.

PRECAUTIONS AFTER USE :

1. Before servicing or repairning, Always stop the engine, remove the plug cap from the spark plug and allow the engine to cool down.
2. Before storing the auger, drain all remaining fuel and wipe the equipment clean of dirt & Weeds.

ASSEMBLY :

GEAR CASE TO ENGINE :

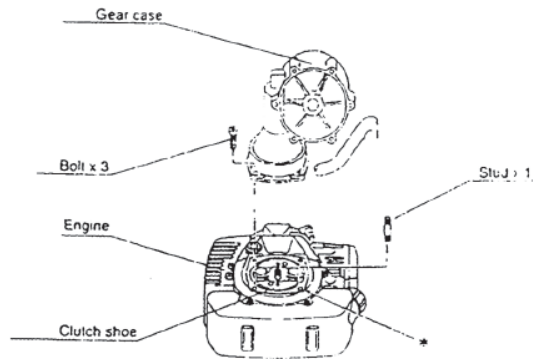

1. Lay the Engine on the ground with the clutch shoe facing upwards. Screw the stud into the marked hole.
2. Set the gear case on the engine and loosely tighten the stud and nut.
3. Stud the other bolts into the remaining 3 holes. Then tighten all the 4 bolts securely and evenly

THROTTLE WIRE ENGINE TO GEAR CASE CONNECTION

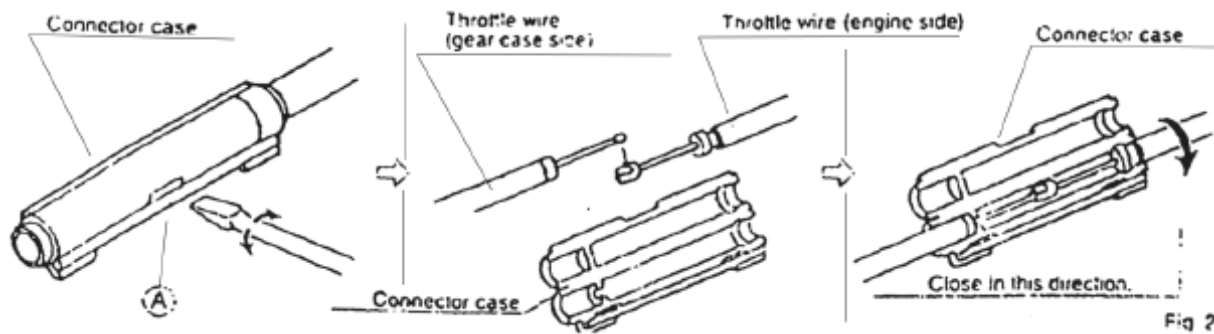

1. Open the connector case using a slotted screw driver at Point A & remove the case.
2. Connect the throttle wire end on the engine side to its counterpart on the gear case side.
3. Reattach the connector case.
4. Close the case securely.

WIRING LEADS

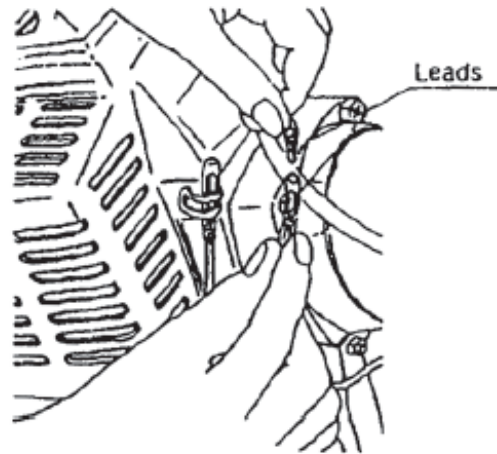

Connect the leads (X2) between the Engine & gear case. Make sure colours match and connections are securely tight.

Fig. 3

DRILL TO GEAR CASE

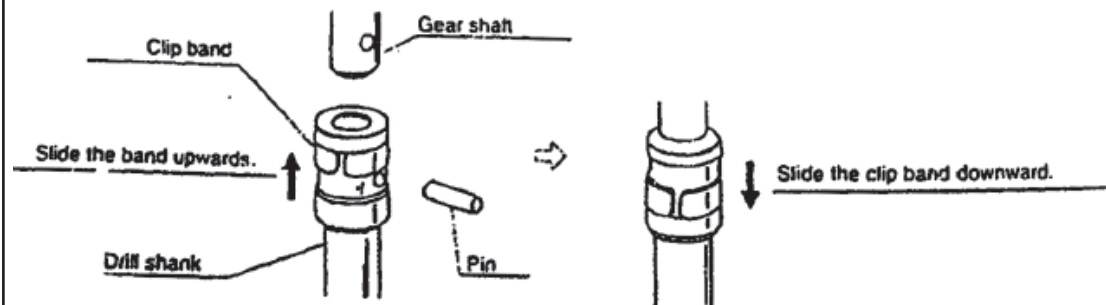
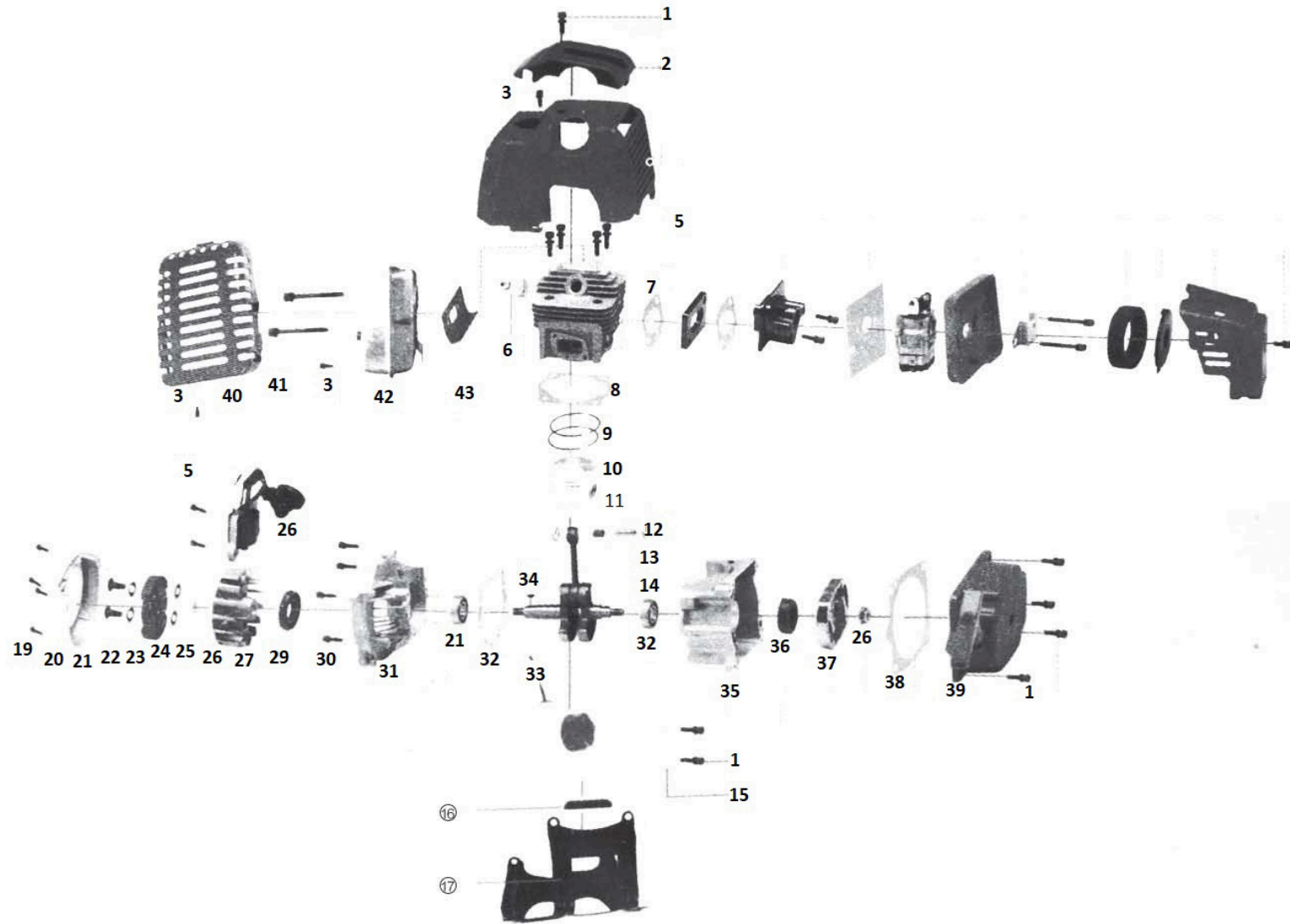

Fig.4

1. Slide the clipband upward and pull the pin out from its hole.
2. Align the holes on the gear shaft and drill shank and insert the drill over the shaft. Reinsert the pin through the pin holes & lower the band until covering the hole.

ENGINE DIAGRAM OF EARTH AUGER



SL NO	PART NO	DESCRIPTION	SL NO	PART NO	DESCRIPTION
1	AM-6300EAW -E01	Single Cylinder head combination Screw	17	AM-6300EAW -E17	Oil Support
2	AM-6300EAW -E02	Cylinder head cover	18	AM-6300EAW -E18	Cushion
3	AM-6300EAW -E03	Single Cylinder head combination Screw	19	AM-6300EAW -E19	Single Cylinder head combination Screw
4	AM-6300EAW -E04	Cylinder Cover	20	AM-6300EAW -E20	Side Cover
5	AM-6300EAW -E05	Single Cylinder head combination Screw	21	AM-6300EAW -E21	Cylinder pin
6	AM-6300EAW -E06	Spark Plug	22	AM-6300EAW -E22	Clutch retaining bolt
7	AM-6300EAW -E07	Cylinder Block	23	AM-6300EAW -E23	Wave Washer
8	AM-6300EAW -E08	Cylinder Block Gasket	24	AM-6300EAW -E24	Clutch
9	AM-6300EAW -E09	Piston Ring	25	AM-6300EAW -E25	Flat washer
10	AM-6300EAW -E10	Piston	26	AM-6300EAW -E26	Flange Nut
11	AM-6300EAW -E11	Piston Pin Retainer Ring	27	AM-6300EAW -E27	Magnetic Flywheel
12	AM-6300EAW -E12	Piston Pin	28	AM-6300EAW -E28	High pressure Bag
13	AM-6300EAW -E13	Piston Pin roller bearing	29	AM-6300EAW -E29	Seal
14	AM-6300EAW -E14	Crank shaft connecting Rod	30	AM-6300EAW -E30	Single Cylinder head combination Screw
15	AM-6300EAW -E15	Large Flat washer	31	AM-6300EAW -E31	Left Crankcase
16	AM-6300EAW -E16	Oil Can Assy	32	AM-6300EAW -E32	Bearings

SL NO	PART NO	DESCRIPTION	SL NO	PART NO	DESCRIPTION
33	AM-6300EAW -E33	Crankcase paper pad	46	AM-6300EAW -E46	Intake pipe
34	AM-6300EAW -E34	Half round key	47	AM-6300EAW -E47	Single Cylinder head combination Screw
35	AM-6300EAW -E35	Right crank case	48	AM-6300EAW -E48	Carburetor paper pad
36	AM-6300EAW -E36	Seal	49	AM-6300EAW -E49	Carburetor
37	AM-6300EAW -E37	Starting Dial	50	AM-6300EAW -E50	Air Filter
38	AM-6300EAW -E38	Aluminium Gasket	51	AM-6300EAW -E51	Air filter support
39	AM-6300EAW -E39	Starter Assy	52	AM-6300EAW -E52	Single Cylinder head combination Screw
40	AM-6300EAW -E40	Muffler Hood	53	AM-6300EAW -E53	Sponge filter
41	AM-6300EAW -E41	Single Cylinder head combination Screw	54	AM-6300EAW -E54	Air filter gland
42	AM-6300EAW -E42	Muffler	55	AM-6300EAW -E55	Air filter cover
43	AM-6300EAW -E43	Muffler paper pad	56	AM-6300EAW -E56	Single Cylinder head combination Screw
44	AM-6300EAW -E44	Air inlet paper pad			
45	AM-6300EAW -E45	Insulation pad			



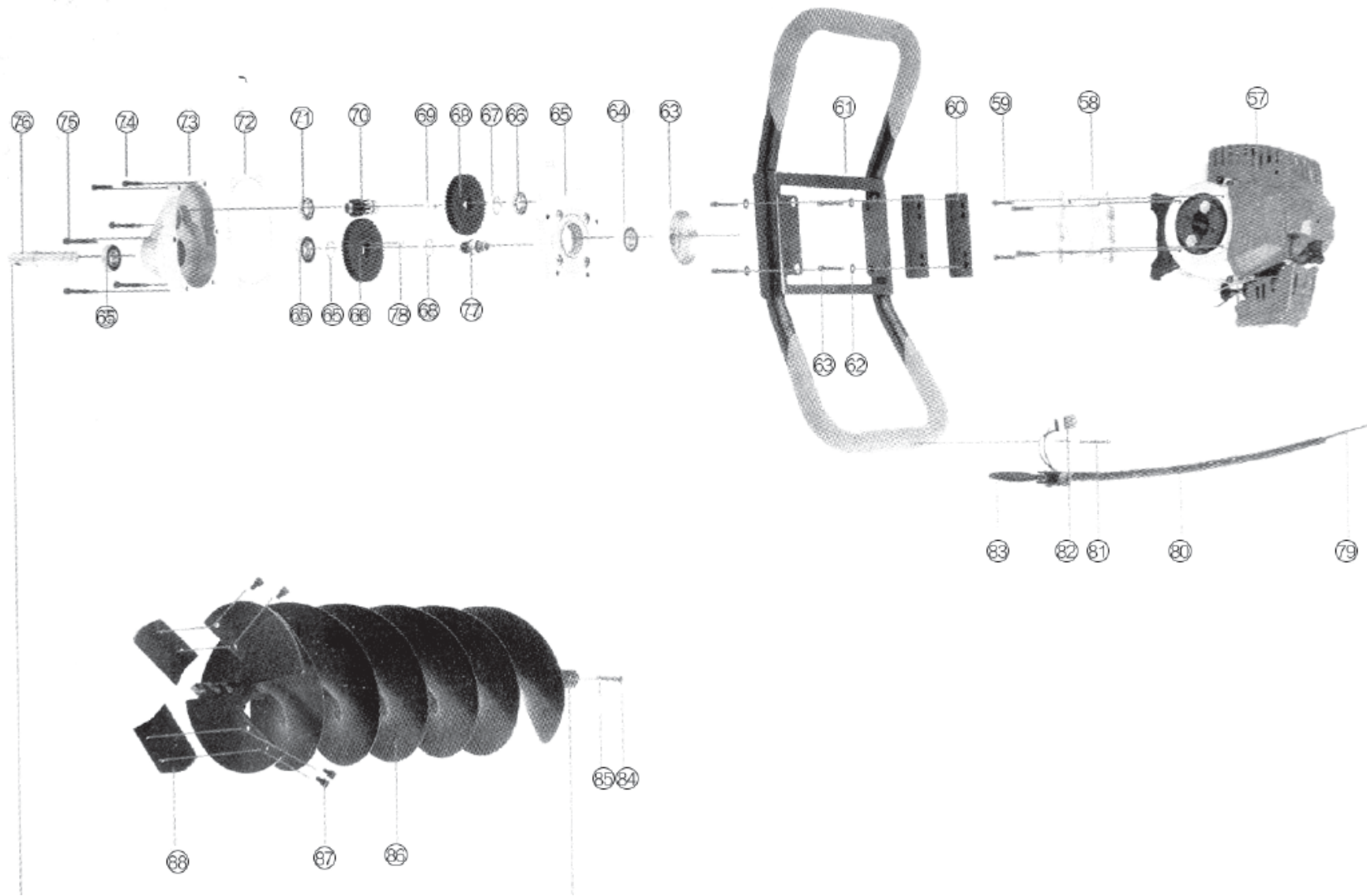

BIT DIAGRAM OF EARTH AUGER



SL NO	PART NO	DESCRIPTION	SL NO	PART NO.	DESCRIPTION
57	AM-6300EAW -B57	Gasoline Engine	73	AM-6300EAW -B73	Gear box
58	AM-6300EAW -B58	Gear Box fixing plate	74	AM-6300EAW -B74	Cylinder head combination screw
59	AM-6300EAW -B59	Cylinder head screw	75	AM-6300EAW -B75	Cylinder head combination screw
60	AM-6300EAW -B60	Rubber Cushion	76	AM-6300EAW -B76	Output shaft
61	AM-6300EAW -B61	Bracket handle	77	AM-6300EAW -B77	Driving gear I
62	AM-6300EAW -B62	Flat washer	78	AM-6300EAW -B78	Drive gear II
63	AM-6300EAW -B63	Cylinder head combination screw	79	AM-6300EAW -B79	Throttle line
64	AM-6300EAW -B64	Clutch disc	80	AM-6300EAW -B80	Bushing
65	AM-6300EAW -B65	Bearing	81	AM-6300EAW -B81	Counter shaft head screw
66	AM-6300EAW -B66	Gear Box cover	82	AM-6300EAW -B82	Engine stop
67	AM-6300EAW -B67	Bearing	83	AM-6300EAW -B83	Throttle switch
68	AM-6300EAW -B68	Shaft ring	84	AM-6300EAW -B84	Pin
69	AM-6300EAW -B69	Driver gear I	85	AM-6300EAW -B85	Pin
70	AM-6300EAW -B70	Cylinder Pin	86	AM-6300EAW -B86	Bit
71	AM-6300EAW -B71	Driver gear II	87	AM-6300EAW -B87	Cylinder head screw
72	AM-6300EAW -B72	Gear Box paper pad	88	AM-6300EAW -B88	Bit Blade





WARRANTY CARD

CUSTOMER COPY

DATE _____	DATE OF DELIVERY _____	DEALERS OFFICIAL SEAL	DEALERS SIGN _____
PURCHASERS NAME & ADDRESS _____ _____	 CUSTOMER SIGN		
PRODUCT NAME	PRODUCT SERIAL NO.	INVOICE/DN NO.	
			





I/Will accept the terms and conditions of warranty as in the warranty card

DEALERS COPY

DATE _____	DATE OF DELIVERY _____	DEALERS OFFICIAL SEAL	DEALERS SIGN _____
PURCHASERS NAME & ADDRESS _____ _____	 CUSTOMER SIGN		
PRODUCT NAME	PRODUCT SERIAL NO.	INVOICE/DN NO.	
			

I/Will accept the terms and conditions of warranty as in the warranty card

COMPANY COPY

DATE _____	DATE OF DELIVERY _____	DEALERS OFFICIAL SEAL	DEALERS SIGN _____
PURCHASERS NAME & ADDRESS _____ _____	 CUSTOMER SIGN		
PRODUCT NAME	PRODUCT SERIAL NO.	INVOICE/DN NO.	
			

I/Will accept the terms and conditions of warranty as in the warranty card

1. LIMITED WARRANTY PERIOD : For a period of six months from the date of Sale / delivery of the product which ever is earlier. 2. LIMITED WARRANTY OBLIGATION : Replacement of defective part(s) by authorized dealer are free of charges. If found defective by reasons of defective material / poor workmanship, parts will be replaced and there will be no value re-imburement. 3. TERMS & CONDITIONS : a. Claims under warranty will be accepted on submission of Warranty Card duly filled and stamped by authorized dealer together with the original purchase document. : b. Shipping / transportation / Incidental charges incurred in replacing defective parts under warranty shall be borne by the purchaser

WARRANTY null & void if

- (i) Lack of maintenance, (ii) Incorrect use of the machine or tampering, (iii) Use of non-genuine spare parts, (iv) Usage of acids, solvents, or any flammable materials, (v) Non-usage of filter water / clear water / soft water & using water above 40°C temperature, (vi) While using the pressure washers to draw water which is contaminated with dust & solvents (eg. paint thinners, gasoline, oil, etc.), (vii) Repair done by unauthorized service people, (viii) Those parts subject to wear & tear due to normal operations and plastic parts, rubber items etc, (ix) Loose connections, faulty electrical fixtures & fluctuations in power supply.
- 4. Should any failure occur during or after the warranty period, customer does not have the right to interrupt payment / price discount.
- 5. Incidental or consequential damages like inconvenience commercial loss, loss of tie, mental agony etc.
- 6. Loss of any nature due to operation or non-operation is not covered under warranty.
- 7. All free service are at Dealer's service point only.
- 8. Warranty ceases if service is not done periodically.
- 9. The attached card should be completed and returned to Ratnagiri Impex Pvt. Ltd. for registration immediately after sale / delivery.
- 10. The warranty is void unless you register the warranty card with Ratnagiri Impex Pvt. Ltd.
- 11. The decision of Ratnagiri Impex Pvt. Ltd., in settling the warranty is final in all respects.
- 12. All disputes are subject to Bangalore Courts Jurisdiction

1. LIMITED WARRANTY PERIOD : For a period of six months from the date of Sale / delivery of the product which ever is earlier. 2. LIMITED WARRANTY OBLIGATION : Replacement of defective part(s) by authorized dealer are free of charges. If found defective by reasons of defective material / poor workmanship, parts will be replaced and there will be no value re-imburement. 3. TERMS & CONDITIONS : a. Claims under warranty will be accepted on submission of Warranty Card duly filled and stamped by authorized dealer together with the original purchase document. : b. Shipping / transportation / Incidental charges incurred in replacing defective parts under warranty shall be borne by the purchaser.

WARRANTY null & void if

- (i) Lack of maintenance, (ii) Incorrect use of the machine or tampering, (iii) Use of non-genuine spare parts, (iv) Usage of acids, solvents, or any flammable materials, (v) Non-usage of filter water / clear water / soft water & using water above 40°C temperature, (vi) While using the pressure washers to draw water which is contaminated with dust & solvents (eg. paint thinners, gasoline, oil, etc.), (vii) Repair done by unauthorized service people, (viii) Those parts subject to wear & tear due to normal operations and plastic parts, rubber items etc, (ix) Loose connections, faulty electrical fixtures & fluctuations in power supply.
- 4. Should any failure occur during or after the warranty period, customer does not have the right to interrupt payment / price discount.
- 5. Incidental or consequential damages like inconvenience commercial loss, loss of tie, mental agony etc.
- 6. Loss of any nature due to operation or non-operation is not covered under warranty.
- 7. All free service are at Dealer's service point only.
- 8. Warranty ceases if service is not done periodically.
- 9. The attached card should be completed and returned to Ratnagiri Impex Pvt. Ltd. for registration immediately after sale / delivery.
- 10. The warranty is void unless you register the warranty card with Ratnagiri Impex Pvt. Ltd.
- 11. The decision of Ratnagiri Impex Pvt. Ltd., in settling the warranty is final in all respects.
- 12. All disputes are subject to Bangalore Courts Jurisdiction

1. LIMITED WARRANTY PERIOD : For a period of six months from the date of Sale / delivery of the product which ever is earlier. 2. LIMITED WARRANTY OBLIGATION : Replacement of defective part(s) by authorized dealer are free of charges. If found defective by reasons of defective material / poor workmanship, parts will be replaced and there will be no value re-imburement. 3. TERMS & CONDITIONS : a. Claims under warranty will be accepted on submission of Warranty Card duly filled and stamped by authorized dealer together with the original purchase document. : b. Shipping / transportation / Incidental charges incurred in replacing defective parts under warranty shall be borne by the purchaser.

WARRANTY null & void if

- (i) Lack of maintenance, (ii) Incorrect use of the machine or tampering, (iii) Use of non-genuine spare parts, (iv) Usage of acids, solvents, or any flammable materials, (v) Non-usage of filter water / clear water / soft water & using water above 40°C temperature, (vi) While using the pressure washers to draw water which is contaminated with dust & solvents (eg. paint thinners, gasoline, oil, etc.), (vii) Repair done by unauthorized service people, (viii) Those parts subject to wear & tear due to normal operations and plastic parts, rubber items etc, (ix) Loose connections, faulty electrical fixtures & fluctuations in power supply.
- 4. Should any failure occur during or after the warranty period, customer does not have the right to interrupt payment / price discount.
- 5. Incidental or consequential damages like inconvenience commercial loss, loss of tie, mental agony etc.
- 6. Loss of any nature due to operation or non-operation is not covered under warranty.
- 7. All free service are at Dealer's service point only.
- 8. Warranty ceases if service is not done periodically.
- 9. The attached card should be completed and returned to Ratnagiri Impex Pvt. Ltd. for registration immediately after sale / delivery.
- 10. The warranty is void unless you register the warranty card with Ratnagiri Impex Pvt. Ltd.
- 11. The decision of Ratnagiri Impex Pvt. Ltd., in settling the warranty is final in all respects.
- 12. All disputes are subject to Bangalore Courts Jurisdiction



FREE SERVICE COUPON (30DAYS/30HRS. WHICHEVER IS EARLIER)

MODEL	<input type="text"/>	SERIAL NUMBER	<input type="text"/>
PDI DATE	SERVICE NO.	PURCHASE BILL NO.	DATE
<input type="text"/>	<input type="text"/>	<input type="text"/>	<input type="text"/>
DEALERS OFFICE SEAL	OPERATIONS		
<input type="text"/>	<ol style="list-style-type: none"> 1. Check and test the fuel mixture 3. Check , clean and adjust the spark plug 5. Check and sparken the cutting tools 7. Start and check the noise, vibration, loosen etc.. 	<ol style="list-style-type: none"> 2. check and clean the air filter 4. Check and adjust the carburetor tuning 6. Product familirisation on usage 8. Routine maintenance and shortage. 	

FREE SERVICE COUPON (30DAYS/30HRS. WHICHEVER IS EARLIER)

MODEL	<input type="text"/>	SERIAL NUMBER	<input type="text"/>
PDI DATE	SERVICE NO.	PURCHASE BILL NO.	DATE
<input type="text"/>	<input type="text"/>	<input type="text"/>	<input type="text"/>
DEALERS OFFICE SEAL	OPERATIONS		
<input type="text"/>	<ol style="list-style-type: none"> 1. Check and test the fuel mixture 3. Check , clean and adjust the spark plug 5. Check and sparken the cutting tools 7. Start and check the noise, vibration, loosen etc.. 	<ol style="list-style-type: none"> 2. check and clean the air filter 4. Check and adjust the carburetor tuning 6. Product familirisation on usage 8. Routine maintenance and shortage. 	

FREE SERVICE COUPON (30DAYS/30HRS. WHICHEVER IS EARLIER)

MODEL	<input type="text"/>	SERIAL NUMBER	<input type="text"/>
PDI DATE	SERVICE NO.	PURCHASE BILL NO.	DATE
<input type="text"/>	<input type="text"/>	<input type="text"/>	<input type="text"/>
DEALERS OFFICE SEAL	OPERATIONS		
<input type="text"/>	<ol style="list-style-type: none"> 1. Check and test the fuel mixture 3. Check , clean and adjust the spark plug 5. Check and sparken the cutting tools 7. Start and check the noise, vibration, loosen etc.. 	<ol style="list-style-type: none"> 2. check and clean the air filter 4. Check and adjust the carburetor tuning 6. Product familirisation on usage 8. Routine maintenance and shortage. 	

DOS

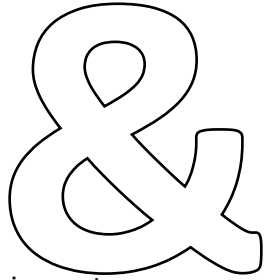

DONTs

attempting to use the equipments.

1. Always read the instruction manual supplied along with the equipments and understand the correct installation and operating procedures before

trousers and jackets while operating potentially dangerous machines
2. It is important to use the personal protection equipments such as head helmet with visor, ear defenders, goggles, safety gloves, cut resistant shoes,
3. Avoid untrained persons using the equipments. Children must not be allowed to handle these equipments
4. Always use genuine spares and accessories in repairs and usage to derive maximum life of the equipments.
5. Always keep the equipments in good working condition to minimize loss of output as well as to reduce the pollution and save the environment
6. Do not use the machine within range of persons unless they wear protective clothing
7. Do not operate the machine when fatigued or under the influence of alcohol or drugs
8. For more query kindly contact for our Service Center/Dealer/ franchise

NO. 1 CHOICE OF FARMERS SINCE 1999



Marketed by.
**ratnagiri
impex**
BRINGING YOU THE FUTURE... NOW

RATNAGIRI IMPEX PVT., LTD.,

Annapurna House, #1 / 1G, 7th Cross, New
Guddadahalli

Mysore Road, Bangalore - 560 026

Missed Call : 7393 938 938

Email: ask@agrimart.in