

AGRIMATE CHAFF CUTTER AM-CCMG-400-3HP-ELITE

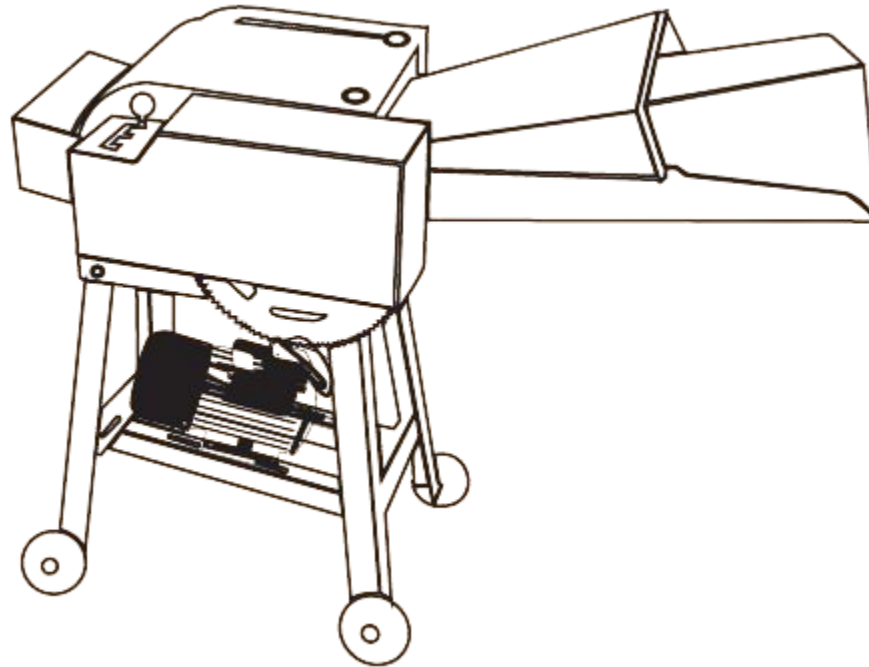

INTRODUCTION

Dear Sir/ Madam,





Thank you for choosing Agrimate product. You are the proud owner of high technology & durable machine. Trust that our Franchisee/Dealer installed the product & installed the product and explained you about the usage & service instructions. Please visit our autorised dealer for your future requirement of our other equipments, genuine spares, accessories and services. Service coupons are attached with this manual and you can avail free service to keep your machine fit always to use on demand.





About Ratnagiri,

We import and market of high quality of agriculture wide range of equipments which we are selling through our authorised franchisee or dealer network. We are in this field from past years service the farmer. community. For further details, Please visit our website www.agrimart.in. & Give a missed call to 7393 938 938.

TECHNICAL SPECIFICATIONS

MODEL	AM-CCMG-400-3HP-ELITE
POWER	3HP
SINGLE SPEED	1000 RPM
VOLTAGE	220 V , 50HZ
CHOPPING CAPACITY	600 - 1000KG/HR.

SL NO.	PART NO.	DESCRIPTION	IMAGES
1	AM-CCM-400-3HP-01	"Feeding roller" "	
2	AM-CCM-400-3HP-02	Fixed blade	
3	AM-CCM-400-3HP-03	"Rotary blade" "	
4	AM-CCM-400-3HP-04	" ""8"" connection (with bearing)"	
5	AM-CCM-400-3HP-05	"small gears" "	

SL NO	PART NO.	DESCRIPTION	IMAGES
6	AM-CCM-400-3HP-06	Gear	 Two black gears of different sizes are shown meshing together. The larger gear is on the left and the smaller one is on the right.
7	AM-CCM-400-3HP-07	Big gears	 A large, silver-colored gear with six spokes radiating from a central hub. It has a serrated outer edge.
8	AM-CCM-400-3HP-08	Pulley	 A silver-colored pulley with six spokes and a central hub. It has a smooth outer rim.
9	AM-CCM-400-3HP-09	Spring	 A black, coiled spring with two curved ends.
10	AM-CCM-400-3HP-10	V-belt	 A black V-belt shown in a circular loop.

INSPECTION & MAINTAINANCE

For safety use, make sure the machine is cleaned every three months. Before working, make sure to inspect the filter and the nozzle and ensure there is no impurity. After working, make sure there is no water in the pump and the hose.

If the machine needs to be repaired in the guarantee period, please return the machine to the shop. You need to provide the certificate of purchase on order to repair or get the substitute.

Before packing, the machine should be cleaned, then use closed packaging, packaging should be firm. Store the machine in dry place.

For transportation safety. The machine should comply with ISTA.





Do not dispose of electrical machines as unsorted municipal waste, use separate collection facilities.

If electrical machines are disposed of in landfills or dumps, hazardous substances can leak into the ground water and get into the food chain, damaging your health and well being.

When replacing old machines with new ones, the retailer is legally obligated to take back your old machine for disposals at least free of charge.





WARRANTY CARD

CUSTOMER COPY

DATE _____	DATE OF DELIVERY _____	DEALERS OFFICIAL SEAL	DEALERS SIGN _____
PURCHASERS NAME & ADDRESS _____ _____	 CUSTOMER SIGN		
PRODUCT NAME	PRODUCT SERIAL NO.	INVOICE/DN NO.	
			

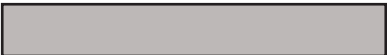



I/Will accept the terms and conditions of warranty as in the warranty card

DEALERS COPY

DATE _____	DATE OF DELIVERY _____	DEALERS OFFICIAL SEAL	DEALERS SIGN _____
PURCHASERS NAME & ADDRESS _____ _____	 CUSTOMER SIGN		
PRODUCT NAME	PRODUCT SERIAL NO.	INVOICE/DN NO.	
			

I/Will accept the terms and conditions of warranty as in the warranty card

COMPANY COPY

DATE _____	DATE OF DELIVERY _____	DEALERS OFFICIAL SEAL	DEALERS SIGN _____
PURCHASERS NAME & ADDRESS _____ _____	 CUSTOMER SIGN		
PRODUCT NAME	PRODUCT SERIAL NO.	INVOICE/DN NO.	
			

I/Will accept the terms and conditions of warranty as in the warranty card

1. LIMITED WARRANTY PERIOD : For a period of six months from the date of Sale / delivery of the product which ever is earlier. 2. LIMITED WARRANTY OBLIGATION : Replacement of defective part(s) by authorized dealer are free of charges. If found defective by reasons of defective material / poor workmanship, parts will be replaced and there will be no value re-imbusement. 3. TERMS & CONDITIONS : a. Claims under warranty will be accepted on submission of Warranty Card duly filled and stamped by authorized dealer together with the original purchase document. : b. Shipping / transportation / Incidental charges incurred in replacing defective parts under warranty shall be borne by the purchaser

WARRANTY null & void if

- (i) Lack of maintenance, (ii) Incorrect use of the machine or tampering, (iii) Use of non-genuine spare parts, (iv) Usage of acids, solvents, or any flammable materials, (v) Non-usage of filter water / clear water / soft water & using water above 40°C temperature, (vi) While using the pressure washers to draw water which is contaminated with dust & solvents (eg. paint thinners, gasoline, oil, etc.), (vii) Repair done by unauthorized service people, (viii) Those parts subject to wear & tear due to normal operations and plastic parts, rubber items etc, (ix) Loose connections, faulty electrical fixtures & fluctuations in power supply.
- 4. Should any failure occur during or after the warranty period, customer does not have the right to interrupt payment / price discount.
- 5. Incidental or consequential damages like inconvenience commercial loss, loss of tie, mental agony etc.
- 6. Loss of any nature due to operation or non-operation is not covered under warranty.
- 7. All free service are at Dealer's service point only.
- 8. Warranty ceases if service is not done periodically.
- 9. The attached card should be completed and returned to Ratnagiri Impex Pvt. Ltd. for registration immediately after sale / delivery.
- 10. The warranty is void unless you register the warranty card with Ratnagiri Impex Pvt. Ltd.
- 11. The decision of Ratnagiri Impex Pvt. Ltd., in settling the warranty is final in all respects.
- 12. All disputes are subject to Bangalore Courts Jurisdiction

1. LIMITED WARRANTY PERIOD : For a period of six months from the date of Sale / delivery of the product which ever is earlier. 2. LIMITED WARRANTY OBLIGATION : Replacement of defective part(s) by authorized dealer are free of charges. If found defective by reasons of defective material / poor workmanship, parts will be replaced and there will be no value re-imbusement. 3. TERMS & CONDITIONS : a. Claims under warranty will be accepted on submission of Warranty Card duly filled and stamped by authorized dealer together with the original purchase document. : b. Shipping / transportation / Incidental charges incurred in replacing defective parts under warranty shall be borne by the purchaser.

WARRANTY null & void if

- (i) Lack of maintenance, (ii) Incorrect use of the machine or tampering, (iii) Use of non-genuine spare parts, (iv) Usage of acids, solvents, or any flammable materials, (v) Non-usage of filter water / clear water / soft water & using water above 40°C temperature, (vi) While using the pressure washers to draw water which is contaminated with dust & solvents (eg. paint thinners, gasoline, oil, etc.), (vii) Repair done by unauthorized service people, (viii) Those parts subject to wear & tear due to normal operations and plastic parts, rubber items etc, (ix) Loose connections, faulty electrical fixtures & fluctuations in power supply.
- 4. Should any failure occur during or after the warranty period, customer does not have the right to interrupt payment / price discount.
- 5. Incidental or consequential damages like inconvenience commercial loss, loss of tie, mental agony etc.
- 6. Loss of any nature due to operation or non-operation is not covered under warranty.
- 7. All free service are at Dealer's service point only.
- 8. Warranty ceases if service is not done periodically.
- 9. The attached card should be completed and returned to Ratnagiri Impex Pvt. Ltd. for registration immediately after sale / delivery.
- 10. The warranty is void unless you register the warranty card with Ratnagiri Impex Pvt. Ltd.
- 11. The decision of Ratnagiri Impex Pvt. Ltd., in settling the warranty is final in all respects.
- 12. All disputes are subject to Bangalore Courts Jurisdiction

1. LIMITED WARRANTY PERIOD : For a period of six months from the date of Sale / delivery of the product which ever is earlier. 2. LIMITED WARRANTY OBLIGATION : Replacement of defective part(s) by authorized dealer are free of charges. If found defective by reasons of defective material / poor workmanship, parts will be replaced and there will be no value re-imbusement. 3. TERMS & CONDITIONS : a. Claims under warranty will be accepted on submission of Warranty Card duly filled and stamped by authorized dealer together with the original purchase document. : b. Shipping / transportation / Incidental charges incurred in replacing defective parts under warranty shall be borne by the purchaser.

WARRANTY null & void if

- (i) Lack of maintenance, (ii) Incorrect use of the machine or tampering, (iii) Use of non-genuine spare parts, (iv) Usage of acids, solvents, or any flammable materials, (v) Non-usage of filter water / clear water / soft water & using water above 40°C temperature, (vi) While using the pressure washers to draw water which is contaminated with dust & solvents (eg. paint thinners, gasoline, oil, etc.), (vii) Repair done by unauthorized service people, (viii) Those parts subject to wear & tear due to normal operations and plastic parts, rubber items etc, (ix) Loose connections, faulty electrical fixtures & fluctuations in power supply.
- 4. Should any failure occur during or after the warranty period, customer does not have the right to interrupt payment / price discount.
- 5. Incidental or consequential damages like inconvenience commercial loss, loss of tie, mental agony etc.
- 6. Loss of any nature due to operation or non-operation is not covered under warranty.
- 7. All free service are at Dealer's service point only.
- 8. Warranty ceases if service is not done periodically.
- 9. The attached card should be completed and returned to Ratnagiri Impex Pvt. Ltd. for registration immediately after sale / delivery.
- 10. The warranty is void unless you register the warranty card with Ratnagiri Impex Pvt. Ltd.
- 11. The decision of Ratnagiri Impex Pvt. Ltd., in settling the warranty is final in all respects.
- 12. All disputes are subject to Bangalore Courts Jurisdiction



FREE SERVICE COUPON (30DAYS/30HRS. WHICHEVER IS EARLIER)

MODEL

SERIAL NUMBER

PDI DATE

SERVICE NO.

PURCHASE BILL NO.

DATE

DEALERS OFFICE SEAL

- 1. Check and test the fuel mixture
- 3. Check , clean and adjust the spark plug
- 5. Check and sparken the cutting tools
- 7. Start and check the noise, vibration, loosen etc..

OPERATIONS

- 2. check and clean the air filter
- 4. Check and adjust the carburetor tuning
- 6. Product familirisation on usage
- 8. Routine maintenance and shortage.

FREE SERVICE COUPON (30DAYS/30HRS. WHICHEVER IS EARLIER)

MODEL

SERIAL NUMBER

PDI DATE

SERVICE NO.

PURCHASE BILL NO.

DATE

DEALERS OFFICE SEAL

- 1. Check and test the fuel mixture
- 3. Check , clean and adjust the spark plug
- 5. Check and sparken the cutting tools
- 7. Start and check the noise, vibration, loosen etc..

OPERATIONS

- 2. check and clean the air filter
- 4. Check and adjust the carburetor tuning
- 6. Product familirisation on usage
- 8. Routine maintenance and shortage.

FREE SERVICE COUPON (30DAYS/30HRS. WHICHEVER IS EARLIER)

MODEL

SERIAL NUMBER

PDI DATE

SERVICE NO.

PURCHASE BILL NO.

DATE

DEALERS OFFICE SEAL

- 1. Check and test the fuel mixture
- 3. Check , clean and adjust the spark plug
- 5. Check and sparken the cutting tools
- 7. Start and check the noise, vibration, loosen etc..

OPERATIONS

- 2. check and clean the air filter
- 4. Check and adjust the carburetor tuning
- 6. Product familirisation on usage
- 8. Routine maintenance and shortage.

DOS

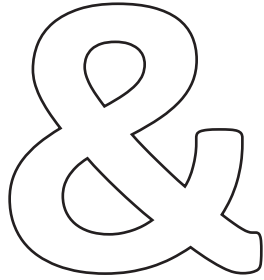

DONTs

1. Always read the instruction manual supplied along with the equipments and understand the correct installation and operating procedures before attempting to use the equipments.
2. It is important to use the personal protection equipments such as head helmet with visor, ear defenders, goggles, safety gloves, cut resistant shoes, trousers and jackets while operating potentially dangerous machines
3. Avoid untrained persons using the equipments. Children must not be allowed to handle these equipments
4. Always use genuine spares and accessories in repairs and usage to derive maximum life of the equipments.
5. Always keep the equipments in good working condition to minimize loss of output as well as to reduce the pollution and save the environment
6. Do not use the machine within range of persons unless they wear protective clothing
7. Do not operate the machine when fatigued or under the influence of alcohol or drugs
8. When the machine is running, please maintain a constant water supply. Without water circulation will damage the sealing rings of the machine.
9. For more query kindly contact for our Service Center/Dealer/ franchise

Agrimate Army For Pest Control

ANY WHERE - ANY TIME - ANY CROP

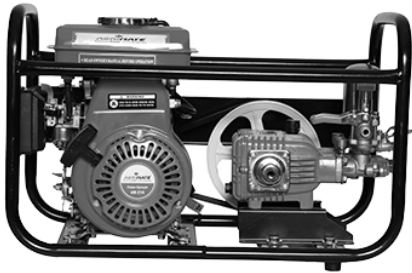
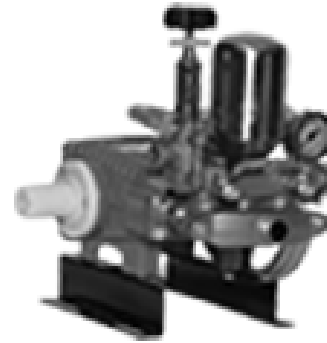

Marketed by:
**ratnagiri
impex**
BRINGING YOU THE FUTURE... NOW

IMPORTED & MARKETED BY,
RATNAGIRI IMPEX PVT., LTD.,

Annapurna House, #1 / 1G, 7th Cross, New
Guddadahalli Mysore Road, Bangalore - 560 026

Missed Call : 7393 938 938 Email: ask@agrimart.in