

AGRIMATE KNAPSACK POWER SPRAYER AM-K435HC-MS+



INTRODUCTION

Dear Sir/ Madam,

Thank you for choosing Agrimate product. You are the proud owner of high technology & durable machine. Trust that our Franchisee/Dealer installed the product & installed the product and explained you about the usage & service instructions. Please visit our autorised dealer for your future requirement of our other equipments, genuine spares, accessories and services. Service coupons are attached with this manual and you can avail free service to keep your machine fit always to use on demand.

About Ratnagiri,

We import and market of high quality of agriculture wide range of equipments which we are selling through our authorised franchisee or dealer network. We are in this field from past years service the farmer. community. For further details, Please visit our website www.agrimart.in. & Give a missed call to 7393 938 938.

TECHNICAL SPECIFICATIONS

MODEL	AM-K43 5HC-MS+
ENGINE	AX-35
TANKCAPACITY	20LTR
PLUNGER DIA	18MM
PRESSURE	25-30(KG/CM2)
OUTPUT	8L/MIN
POWER	1KW/1.3HP

PUMP DIAGRAM & PART LIST OF AM-K435HC-MS+ KNAPSACK POWER SPRAYER

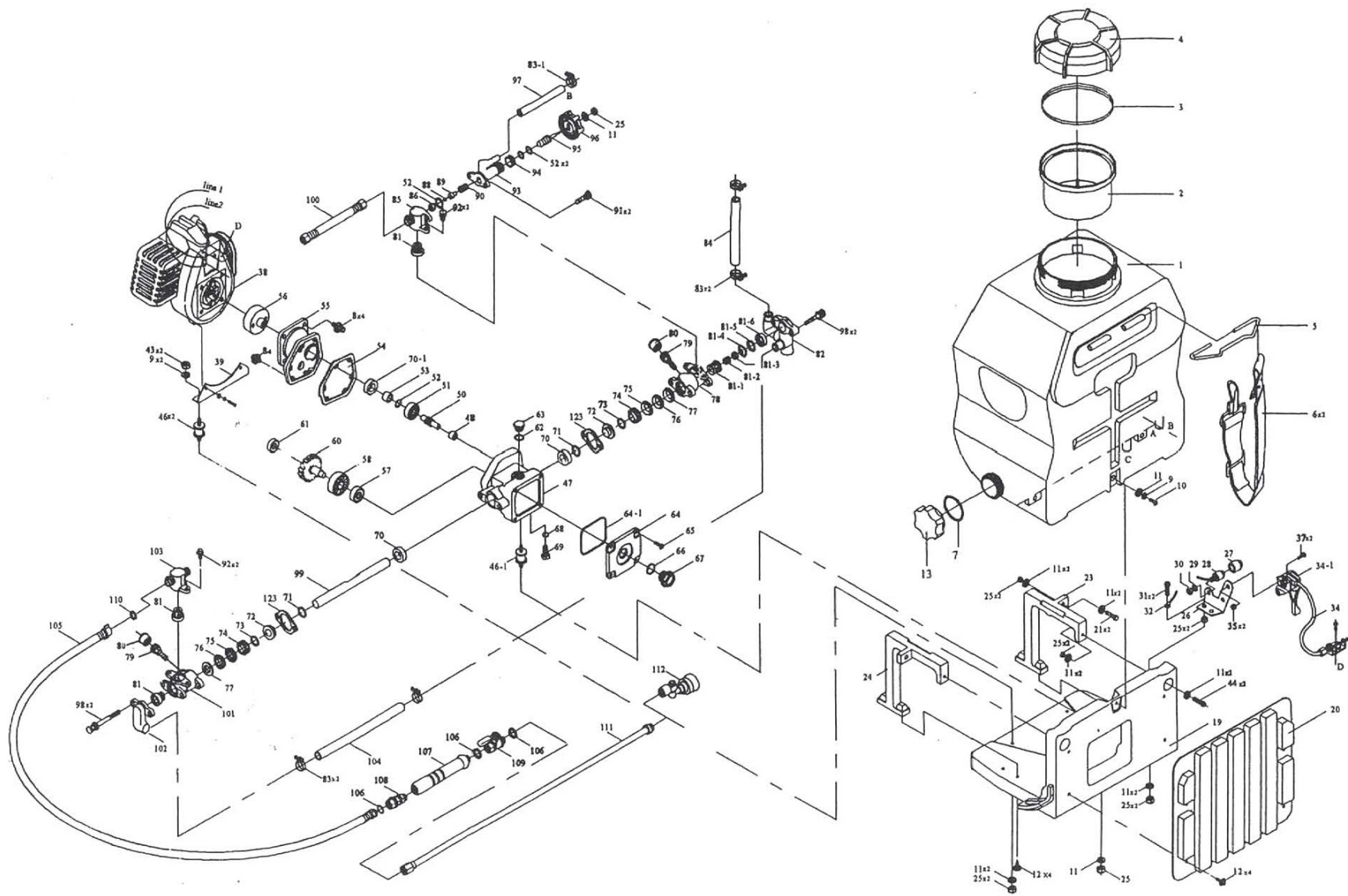

PART NO	DESCRIPTION	PART NO	DESCRIPTION
AM-K435HC-TA01	Chemical Container	AM-K435HC-TA24	Left Stand
AM-K435HC-TA02	Filter	AM-K435HC-TA26	Fixed Plate
AM-K435HC-TA03	Gasket	AM-K435HC-TA28	Stop Switch
AM-K435HC-TA04	Container Cover	AM-K435HC-TA32	Cord Comp
AM-K435HC-TA05	Chain Holder	AM-K435HC-TA34	Throttle Wire
AM-K435HC-TA06	Strap	AM-K435HC-TA34.1	Throttle Lever
AM-K435HC-TA07	Gasket	AM-K435HC-TA39	Engine Stand
AM-K435HC-TA08	Screw	AM-K435HC-TA46	Joint S
AM-K435HC-TA09	Spring Washer	AM-K435HC-TA46.1	Joint-L
AM-K435HC-TA10	Screw	AM-K435HC-TA47	Crank Case
AM-K435HC-TA11	Washer	AM-K435HC-TA48	Bearing
AM-K435HC-TA12	Screw	AM-K435HC-TA50	Shaft
AM-K435HC-TA13	Drain Cup	AM-K435HC-TA51	Bearing
AM-K435HC-TA19	Frame	AM-K435HC-TA52	O-Ring
AM-K435HC-TA20	Pad	AM-K435HC-TA53	Steel Pipe
AM-K435HC-TA23	Right Stand	AM-K435HC-TA54	Gasket

PART NO	DESCRIPTION	PART NO	DESCRIPTION
AM-K435HC-TA55	Drum Case	AM-K435HC-TA71	O-Ring
AM-K435HC-TA56	Drum Clutch	AM-K435HC-TA72	Adjusting Ring
AM-K435HC-TA57	Bearing	AM-K435HC-TA73	Grease Ring
AM-K435HC-TA58	Bearing	AM-K435HC-TA74	V-Packing Upper Seal
AM-K435HC-TA60	Gear Shaft and Gear	AM-K435HC-TA75	V-Packing
AM-K435HC-TA61	Bearing	AM-K435HC-TA77	Packing Seat
AM-K435HC-TA62	O-Ring	AM-K435HC-TA78	Cylinder
AM-K435HC-TA63	Oil Inlet Cup	AM-K435HC-TA79	Grease Cup
AM-K435HC-TA64	Crankcase Cover	AM-K435HC-TA80	Grease Cup
AM-K435HC-TA64.1	O-Ring	AM-K435HC-TA81	Valve Assy
AM-K435HC-TA66	O-Ring	AM-K435HC-TA82	Suction Chamber
AM-K435HC-TA67	Oil Glass	AM-K435HC-TA83	Clip-L
AM-K435HC-TA68	O-Ring	AM-K435HC-TA83.1	Clip-S
AM-K435HC-TA69	Drain Plug	AM-K435HC-TA84	Suction Hose
AM-K435HC-TA70	Oil Seal	AM-K435HC-TA85	Outlet Chamber
AM-K435HC-TA70.1	Oil Seal	AM-K435HC-TA86	Valve Seat

PART NO	DESCRIPTION	PART NO	DESCRIPTION
AM-K435HC-TA88	Pressure Valve	AM-K435HC-TA101	Cylinder
AM-K435HC-TA89	Pressure Valve Rod	AM-K435HC-TA102	Suction Chamber
AM-K435HC-TA90	Spring	AM-K435HC-TA103	Outlet Chamber
AM-K435HC-TA93	Relief Valve Assy	AM-K435HC-TA104	Suction Hose
AM-K435HC-TA94	Nut	AM-K435HC-TA105	High Pressure Hose
AM-K435HC-TA95	Pressure Valve Screw	AM-K435HC-TA107	Hose Pipe Handle
AM-K435HC-TA96	Pressure Adjusting	AM-K435HC-TA108	Roller
AM-K435HC-TA97	Overflow Hose	AM-K435HC-TA109	Ball Cock
AM-K435HC-TA99	Plunger	AM-K435HC-TA111	Spray Rod
AM-K435HC-TA100	High Pressure Hose	AM-K435HC-TA123	Fixed Plate

ENGINE DIAGRAM & PART LIST OF AMK-435HC-MS+

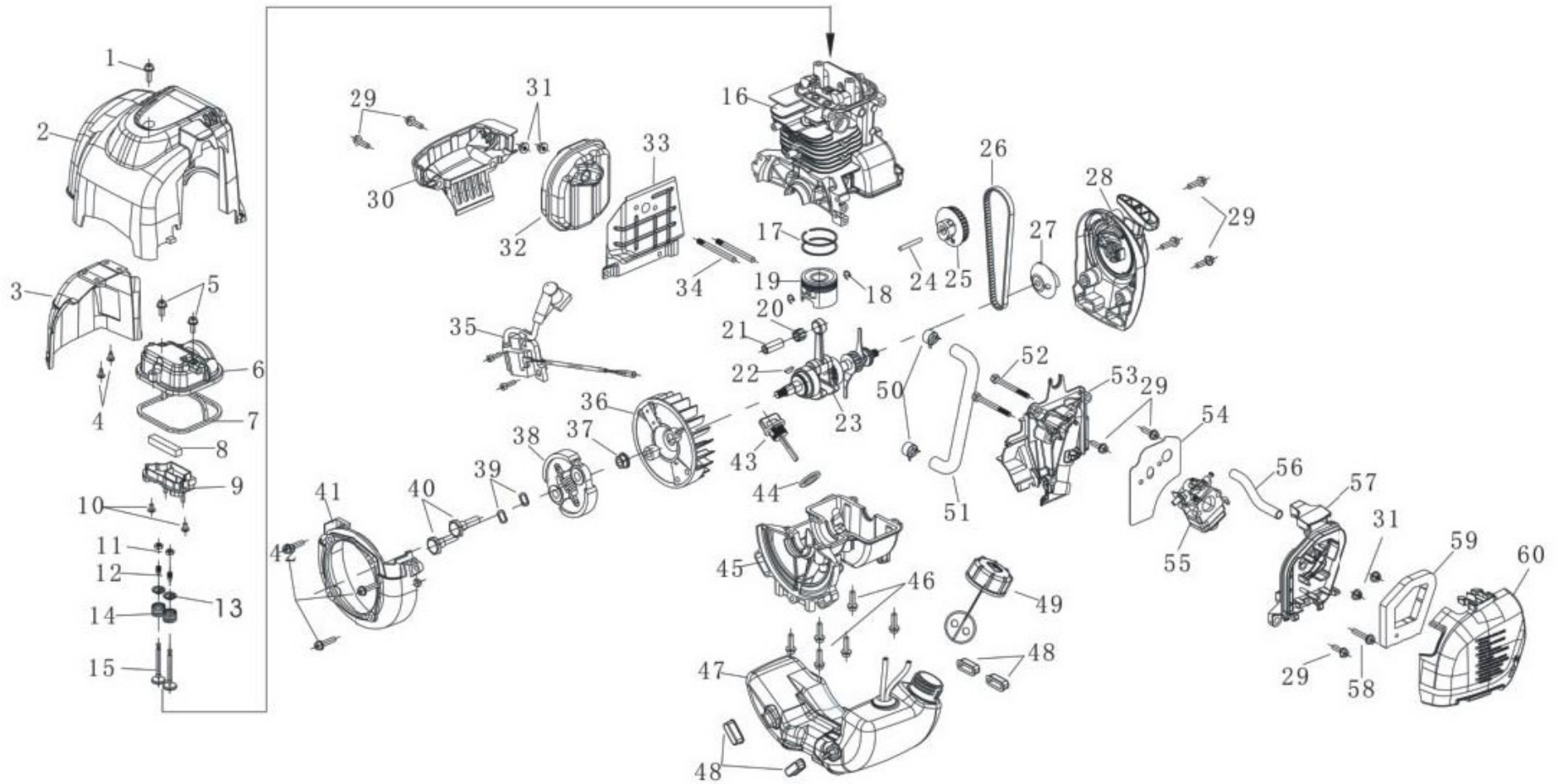

SL NO	PART NO	DESCRIPTION	SL NO	PART NO	DESCRIPTION
1	AX-35-E01	Screw	17	AX-35-E17	Piston Ring
2	AX-35-E02	Cylinder Cover	18	AX-35-E18	Piston Clip
3	AX-35-E03	Muffler Cover	19	AX-35-E19	Piston Clip
4	AX-35-E04	Screw	20	AX-35-E20	Needle Valve
5	AX-35-E05	Screw	21	AX-35-E21	Piston Pin
6	AX-35-E06	Cylinder Head	22	AX-35-E22	Semi Key
7	AX-35-E07	Sealing for cylinder head	23	AX-35-E23	Crankshaft
8	AX-35-E08	Filter	24	AX-35-E24	Gear Bearing
9	AX-35-E09	Oil return Plate	25	AX-35-E25	Cam Wheel
10	AX-35-E10	Screw	26	AX-35-E26	Timing Belt
11	AX-35-E11	Adjusting Nut	27	AX-35-E27	Oil Pump
12	AX-35-E12	Adjusting Screw	28	AX-35-E28	Recoil Starter
13	AX-35-E13	Valve Rock	29	AX-35-E29	Screw
14	AX-35-E14	Valve cover	30	AX-35-E30	Baffle
15	AX-35-E15	Valve	31	AX-35-E31	Nut
16	AX-35-E16	Cylinder	32	AX-35-E32	Muffler

SL NO	PART NO	DESCRIPTION	SL NO	PART NO	DESCRIPTION
33	AX-35-E33	Heat Insulator	49	AX-35-E49	Fuel Tank Cap
34	AX-35-E34	Screw	50	AX-35-E50	Clip
35	AX-35-E35	Ignition Coil	51	AX-35-E51	Oil Pipe
36	AX-35-E36	Fly Wheel	52	AX-35-E52	Screw
37	AX-35-E37	Nut	53	AX-35-E53	Intake manifold
38	AX-35-E38	Clutch	54	AX-35-E54	Gasket
39	AX-35-E39	Washer	55	AX-35-E55	Carburetor
40	AX-35-E40	Clutch Screw	56	AX-35-E56	Exhaust Pipe
41	AX-35-E41	Side Cover	57	AX-35-E57	Air Filter pipe
42	AX-35-E42	Screw	58	AX-35-E58	Screw
43	AX-35-E43	Oil Dipsticks	59	AX-35-E59	Air element
44	AX-35-E44	O -Ring	60	AX-35-E60	Air Filter cover
45	AX-35-E45	CrankCase			
46	AX-35-E46	Screw			
47	AX-35-E47	Fuel Tank			
48	AX-35-E48	Anti Vibration gasket			

INSPECTION & MAINTAINANCE

For safety use, make sure the machine is cleaned every three months. Before working, make sure to inspect the filter and the nozzle and ensure there is no impurity. After working, make sure there is no water in the pump and the hose.

If the machine needs to be repaired in the guarantee period, please return the machine to the shop. You need to provide the certificate of purchase on order to repair or get the substitute.

Before packing, the machine should be cleaned, then use closed packaging, packaging should be firm. Store the machine in dry place.

For transportation safety. The machine should comply with ISTA.





Do not dispose of electrical machines as unsorted municipal waste, use separate collection facilities.

If electrical machines are disposed of in landfills or dumps, hazardous substances can leak into the ground water and get into the food chain, damaging your health and well being.

When replacing old machines with new ones, the retailer is legally obligated to take back your old machine for disposals at least free of charge.





WARRANTY CARD

CUSTOMER COPY

DATE _____	DATE OF DELIVERY _____	DEALERS OFFICIAL SEAL	DEALERS SIGN _____
PURCHASERS NAME & ADDRESS _____ _____	 CUSTOMER SIGN		
PRODUCT NAME	PRODUCT SERIAL NO.	INVOICE/DN NO.	
			

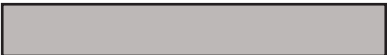



I/Will accept the terms and conditions of warranty as in the warranty card

DEALERS COPY

DATE _____	DATE OF DELIVERY _____	DEALERS OFFICIAL SEAL	DEALERS SIGN _____
PURCHASERS NAME & ADDRESS _____ _____	 CUSTOMER SIGN		
PRODUCT NAME	PRODUCT SERIAL NO.	INVOICE/DN NO.	
			

I/Will accept the terms and conditions of warranty as in the warranty card

COMPANY COPY

DATE _____	DATE OF DELIVERY _____	DEALERS OFFICIAL SEAL	DEALERS SIGN _____
PURCHASERS NAME & ADDRESS _____ _____	 CUSTOMER SIGN		
PRODUCT NAME	PRODUCT SERIAL NO.	INVOICE/DN NO.	
			

I/Will accept the terms and conditions of warranty as in the warranty card

1. LIMITED WARRANTY PERIOD : For a period of six months from the date of Sale / delivery of the product which ever is earlier. 2. LIMITED WARRANTY OBLIGATION : Replacement of defective part(s) by authorized dealer are free of charges. If found defective by reasons of defective material / poor workmanship, parts will be replaced and there will be no value re-imburement. 3. TERMS & CONDITIONS : a. Claims under warranty will be accepted on submission of Warranty Card duly filled and stamped by authorized dealer together with the original purchase document. : b. Shipping / transportation / Incidental charges incurred in replacing defective parts under warranty shall be borne by the purchaser

WARRANTY null & void if

- (i) Lack of maintenance, (ii) Incorrect use of the machine or tampering, (iii) Use of non-genuine spare parts, (iv) Usage of acids, solvents, or any flammable materials, (v) Non-usage of filter water / clear water / soft water & using water above 40°C temperature, (vi) While using the pressure washers to draw water which is contaminated with dust & solvents (eg. paint thinners, gasoline, oil, etc.), (vii) Repair done by unauthorized service people, (viii) Those parts subject to wear & tear due to normal operations and plastic parts, rubber items etc, (ix) Loose connections, faulty electrical fixtures & fluctuations in power supply.
- 4. Should any failure occur during or after the warranty period, customer does not have the right to interrupt payment / price discount.
- 5. Incidental or consequential damages like inconvenience commercial loss, loss of tie, mental agony etc.
- 6. Loss of any nature due to operation or non-operation is not covered under warranty.
- 7. All free service are at Dealer's service point only.
- 8. Warranty ceases if service is not done periodically.
- 9. The attached card should be completed and returned to Ratnagiri Impex Pvt. Ltd. for registration immediately after sale / delivery.
- 10. The warranty is void unless you register the warranty card with Ratnagiri Impex Pvt. Ltd.
- 11. The decision of Ratnagiri Impex Pvt. Ltd., in settling the warranty is final in all respects.
- 12. All disputes are subject to Bangalore Courts Jurisdiction

1. LIMITED WARRANTY PERIOD : For a period of six months from the date of Sale / delivery of the product which ever is earlier. 2. LIMITED WARRANTY OBLIGATION : Replacement of defective part(s) by authorized dealer are free of charges. If found defective by reasons of defective material / poor workmanship, parts will be replaced and there will be no value re-imburement. 3. TERMS & CONDITIONS : a. Claims under warranty will be accepted on submission of Warranty Card duly filled and stamped by authorized dealer together with the original purchase document. : b. Shipping / transportation / Incidental charges incurred in replacing defective parts under warranty shall be borne by the purchaser.

WARRANTY null & void if

- (i) Lack of maintenance, (ii) Incorrect use of the machine or tampering, (iii) Use of non-genuine spare parts, (iv) Usage of acids, solvents, or any flammable materials, (v) Non-usage of filter water / clear water / soft water & using water above 40°C temperature, (vi) While using the pressure washers to draw water which is contaminated with dust & solvents (eg. paint thinners, gasoline, oil, etc.), (vii) Repair done by unauthorized service people, (viii) Those parts subject to wear & tear due to normal operations and plastic parts, rubber items etc, (ix) Loose connections, faulty electrical fixtures & fluctuations in power supply.
- 4. Should any failure occur during or after the warranty period, customer does not have the right to interrupt payment / price discount.
- 5. Incidental or consequential damages like inconvenience commercial loss, loss of tie, mental agony etc.
- 6. Loss of any nature due to operation or non-operation is not covered under warranty.
- 7. All free service are at Dealer's service point only.
- 8. Warranty ceases if service is not done periodically.
- 9. The attached card should be completed and returned to Ratnagiri Impex Pvt. Ltd. for registration immediately after sale / delivery.
- 10. The warranty is void unless you register the warranty card with Ratnagiri Impex Pvt. Ltd.
- 11. The decision of Ratnagiri Impex Pvt. Ltd., in settling the warranty is final in all respects.
- 12. All disputes are subject to Bangalore Courts Jurisdiction

1. LIMITED WARRANTY PERIOD : For a period of six months from the date of Sale / delivery of the product which ever is earlier. 2. LIMITED WARRANTY OBLIGATION : Replacement of defective part(s) by authorized dealer are free of charges. If found defective by reasons of defective material / poor workmanship, parts will be replaced and there will be no value re-imburement. 3. TERMS & CONDITIONS : a. Claims under warranty will be accepted on submission of Warranty Card duly filled and stamped by authorized dealer together with the original purchase document. : b. Shipping / transportation / Incidental charges incurred in replacing defective parts under warranty shall be borne by the purchaser.

WARRANTY null & void if

- (i) Lack of maintenance, (ii) Incorrect use of the machine or tampering, (iii) Use of non-genuine spare parts, (iv) Usage of acids, solvents, or any flammable materials, (v) Non-usage of filter water / clear water / soft water & using water above 40°C temperature, (vi) While using the pressure washers to draw water which is contaminated with dust & solvents (eg. paint thinners, gasoline, oil, etc.), (vii) Repair done by unauthorized service people, (viii) Those parts subject to wear & tear due to normal operations and plastic parts, rubber items etc, (ix) Loose connections, faulty electrical fixtures & fluctuations in power supply.
- 4. Should any failure occur during or after the warranty period, customer does not have the right to interrupt payment / price discount.
- 5. Incidental or consequential damages like inconvenience commercial loss, loss of tie, mental agony etc.
- 6. Loss of any nature due to operation or non-operation is not covered under warranty.
- 7. All free service are at Dealer's service point only.
- 8. Warranty ceases if service is not done periodically.
- 9. The attached card should be completed and returned to Ratnagiri Impex Pvt. Ltd. for registration immediately after sale / delivery.
- 10. The warranty is void unless you register the warranty card with Ratnagiri Impex Pvt. Ltd.
- 11. The decision of Ratnagiri Impex Pvt. Ltd., in settling the warranty is final in all respects.
- 12. All disputes are subject to Bangalore Courts Jurisdiction



FREE SERVICE COUPON (30DAYS/30HRS. WHICHEVER IS EARLIER)

MODEL

SERIAL NUMBER

PDI DATE

SERVICE NO.

PURCHASE BILL NO.

DATE

DEALERS OFFICE SEAL

- 1. Check and test the fuel mixture
- 3. Check , clean and adjust the spark plug
- 5. Check and sparken the cutting tools
- 7. Start and check the noise, vibration, loosen etc..

OPERATIONS

- 2. check and clean the air filter
- 4. Check and adjust the carburetor tuning
- 6. Product familirisation on usage
- 8. Routine maintenance and shortage.

FREE SERVICE COUPON (30DAYS/30HRS. WHICHEVER IS EARLIER)

MODEL

SERIAL NUMBER

PDI DATE

SERVICE NO.

PURCHASE BILL NO.

DATE

DEALERS OFFICE SEAL

- 1. Check and test the fuel mixture
- 3. Check , clean and adjust the spark plug
- 5. Check and sparken the cutting tools
- 7. Start and check the noise, vibration, loosen etc..

OPERATIONS

- 2. check and clean the air filter
- 4. Check and adjust the carburetor tuning
- 6. Product familirisation on usage
- 8. Routine maintenance and shortage.

FREE SERVICE COUPON (30DAYS/30HRS. WHICHEVER IS EARLIER)

MODEL

SERIAL NUMBER

PDI DATE

SERVICE NO.

PURCHASE BILL NO.

DATE

DEALERS OFFICE SEAL

- 1. Check and test the fuel mixture
- 3. Check , clean and adjust the spark plug
- 5. Check and sparken the cutting tools
- 7. Start and check the noise, vibration, loosen etc..

OPERATIONS

- 2. check and clean the air filter
- 4. Check and adjust the carburetor tuning
- 6. Product familirisation on usage
- 8. Routine maintenance and shortage.

DOS

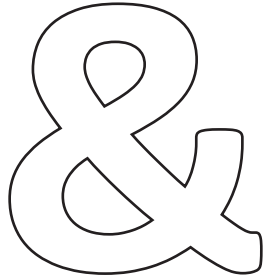

DONT'S

1. Always read the instruction manual supplied along with the equipments and understand the correct installation and operating procedures before attempting to use the equipments.
2. It is important to use the personal protection equipments such as head helmet with visor, ear defenders, goggles, safety gloves, cut resistant shoes, trousers and jackets while operating potentially dangerous machines
3. Avoid untrained persons using the equipments. Children must not be allowed to handle these equipments
4. Always use genuine spares and accessories in repairs and usage to derive maximum life of the equipments.
5. Always keep the equipments in good working condition to minimize loss of output as well as to reduce the pollution and save the environment
6. Do not use the machine within range of persons unless they wear protective clothing
7. Do not operate the machine when fatigued or under the influence of alcohol or drugs
8. When the machine is running, please maintain a constant water supply. Without water circulation will damage the sealing rings of the machine.
9. For more query kindly contact for our Service Center/Dealer/ franchise

Agrimate Army For Pest Control

ANY WHERE - ANY TIME - ANY CROP

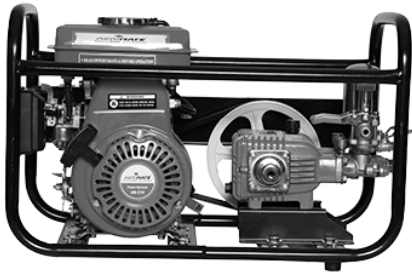
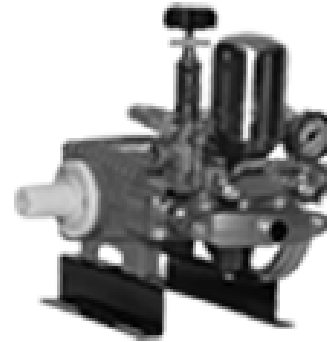

Marketed by:
**ratnagiri
impex**
BRINGING YOU THE FUTURE... NOW

IMPORTED & MARKETED BY,
RATNAGIRI IMPEX PVT., LTD.,

Annapurna House, #1 / 1G, 7th Cross, New
Guddadahalli Mysore Road, Bangalore - 560 026

Missed Call : 7393 938 938 Email: ask@agrimart.in