

AMH-P769 PRO 
with GX35
Portable Power Sprayer



DISCLAIMER: DUE TO CONSTANT UPGRADATION, FEATURES AND SPECIFICATIONS ARE SUBJECT TO CHANGE WITHOUT NOTICE



BEFORE OPERATING THIS MACHINE,
PLEASE READ THESE INSTRUCTIONS CAREFULLY

CAUTION

1. Stop running the gasoline engine before the tank is refueled, and ensure that the gasoline engine is far from the fire. Against the position, discharge the exhaust gas from the rooms, channels using gasoline engine or any other closed places.
2. Forbid to touch the muffler and the body when the gasoline engine runs and just stops.
3. Don't touch the ignition plug cap and wires, to avoid the electrical shock
4. Forbid children and persons unconcerned to touch the gasoline engine.
5. Ensure the cooling of the muffler and the body, cover the gasoline engine after daily work.
6. Against the problem, the damage or the misfire of gasoline engine, check and maintain the gasoline regularly and clean the deposit carbon in the muffler and in the cylinder exhaust.
7. Forbid to use pure gasoline (without two-stroke engine oil) as fuel.
8. Against the damage of gasoline engine and the instruments, forbid to accelerate abruptly, to run speedily and stop abruptly.
9. Forbid the drunk, the dizzy and the pregnant to use the gasoline engine.

PREPARATION

Refuel

Use the mixture of the gasoline and the two stroke engine oil, the volume ratio is 25-30:1 (Fig-1)

Check and clean the air filter

The air filter must be often cleaned, or the polluted air filter will lower the output power of the engine. If the core is blocked by dust, use gasoline to clean the core and the inside of the air filter, then dip in the oil, wring oil out and put the core back (Fig 2)

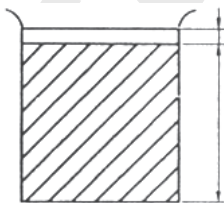

Fig 1

1. The FC Two-stroke engine oil
25. The Gasoline

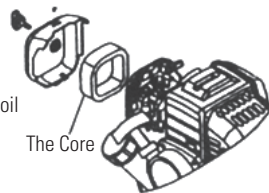

Fig 2

START UP

1. Turn on the gasoline switch until the gasoline flows out the clear plastic pipe. (Fig 3)
2. Close the choke totally (Fig 4)
If the engine is heated, the choke must be totally opened.
3. Open half the throttle.
4. Draw the starter several times slowly, and then draw quickly.

Note: If the excessive gasoline causes the difficult start, take down the ignition plug and the input pipe, open the choke and the throttle totally, draw the starter several times then install the input pipe and start the engine. After the startup, open the choke totally.



Fig 3

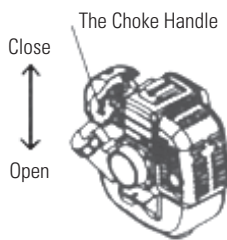

Fig 4

RUNNING

1. After the engine starts, run 3-5 minutes at a low speed
2. When the engine is heated enough, adjust the throttle handle to the corresponding speed.
3. Note: don't accelerate abruptly due to bad lubrication of the engine at the beginning of startup.
4. Avoid the speedy idle motion and over speed motion. If the throttle is totally opened, the engine will run over speed, which not only shortens the service life of the engine but also causes more problems in the engine.

STOPPING

1. Reduce the gasoline engine to the slowest speed and run 3-5 mins
2. Press the stop switch to stop the engine.

MAINTENANCE

1. Daily check

- Check all screws and nuts
- Check oil leakage or air leakage

2. Check after running 20 hours

- Clean the core of the air cleaner
- Clean the gasoline filter

3. Check after running 50 hours

- Refasten the nuts of the cylinder
- Clean the accumulated carbon both in the combustion chamber and in the exhaust of the cylinder
- Clean the accumulated carbon in the ignition plug, adjust the clearance to 0.6mm (Fig 5)
- Clean the accumulated carbon both in the intake and in the exhaust of the muffler (Fig 6,7)

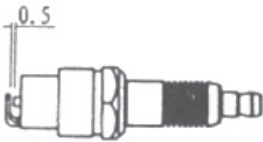

Fig 5

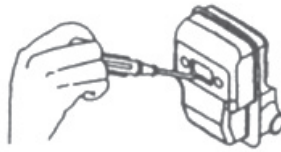

Fig 6

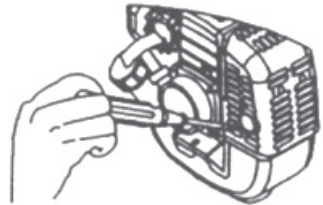

Fig 7

STORAGE

If the gasoline engine isn't used for a long time, it must be maintained as follows:

1. Remove the fuel in the tank and in the carburetor, close the choke totally, draw the starter 3-5 times.
2. Take down the spark plug, add certain engine oil from the spark plug hole into the cylinder, and draw the starter 2-3 times to move the piston to the top dead center, then install the spark plug.
3. Use the soft cloth with engine oil to clean the surface of the engine, stor the engine in a dry and windy place for the next use.

TRUBLE SHOOTING

1. Fail to start

- Oil switch is not turned on
- Gasoline is mixed with water, replace it
- The ignition plug has accumulated carbon or has been broken
- Poor contact of the high voltage wire with the spark plug

2. The engine can start, but can't run fast

- The choke is either open or closed fully
- The ratio of engine oil and the gasoline is normal or not
- Maybe there is water in gasoline

3. The gasoline engine can run, but has not enough power

- Maybe the core of the air filter is blocked by dust
- Maybe the cylinder exhaust and the muffler are blocked by accumulated carbon
- The piston, the piston rings and cylinder have been badly worn out
- Maybe the gasoline filter is blocked by dust
- The body or the top of the shaft has oil leakage and air leakage

4. The gasoline engine stops suddenly when running

- Run out of the gasoline
- The high voltage wire drops
- The ignition plug has accumulated carbon or has been broken
- The gasoline filter is blocked by dust
- Maybe there is water in the gasoline
- The air hole of the tank lid is blocked by dust

STAND DIAGRAM OF PORTABLE POWER SPRAYER AMH-P769 PRO with GX35

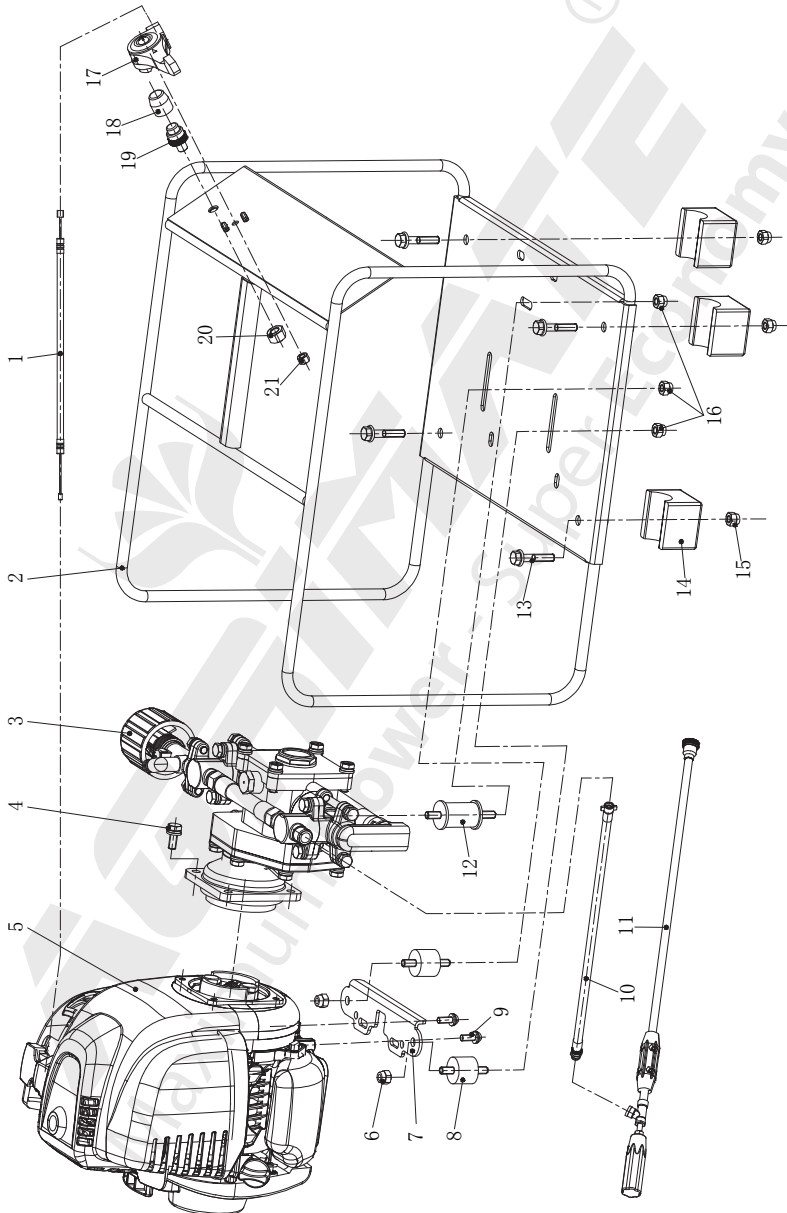

STAND PARTS LIST OF PORTABLE POWER SPRAYER AMH-P769 PRO with GX35

S.N.	PART NO.	DESCRIPTION
1	AMHP 769 PRO S01	Cable
2	AMHP 769 PRO S02	Frame
3	AMHP 769 PRO S03	Pump with ceramic plunger
4	AMHP 769 PRO S04	Bolt M6*16
5	AMHP 769 PRO S05	Engine
6	AMHP 769 PRO S06	Screw M6
7	AMHP 769 PRO S07	Engine Stand
8	AMHP 769 PRO S08	Joint (Engine)
9	AMHP 769 PRO S09	Bolt M5*14
10	AMHP 769 PRO S10	Hose
11	AMHP 769 PRO S11	Straight Gun

S.N.	PART NO.	DESCRIPTION
12	AMHP 769 PRO S12	Joint(Pump)
13	AMHP 769 PRO S13	Joint (M6*30)
14	AMHP 769 PRO S14	Joint
15	AMHP 769 PRO S15	Nut M6
16	AMHP 769 PRO S16	Nut M6
17	AMHP 769 PRO S17	Flex Accelerator
18	AMHP 769 PRO S18	Engine Stop Protector
19	AMHP 769 PRO S19	Engine Stop Switch
20	AMHP 769 PRO S20	Nut M8
21	AMHP 769 PRO S21	Nut M5

For Engine Diagram & Spare Parts
Refer GX35 Engine Manual

PUMP SPARE PARTS DIAGRAM OF PORTABLE POWER SPRAYER AMH-P769 PRO with GX35

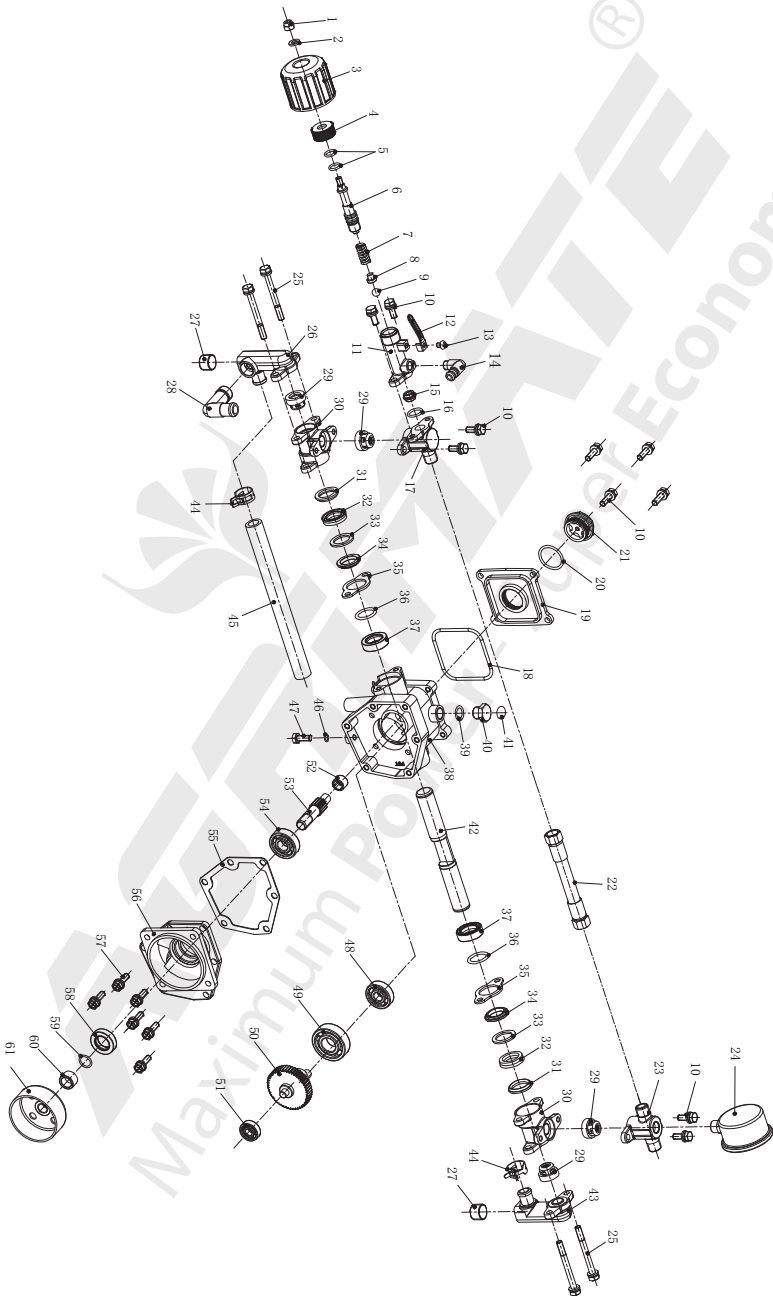

PUMP SPARE PARTS LIST OF PORTABLE POWER SPRAYER AMH-P769 PRO with GX35

S.N.	PART NO.	DESCRIPTION
1	AMH-P769-PRO-PG 01	NutM6
2	AMH-P769-PRO-PG 02	Washer
3	AMH-P769-PRO-PG 03	Pressure Adjusting
4	AMH-P769-PRO-PG 04	LockHandle
5	AMH-P769-PRO-PG 05	Nut
6	AMH-P769-PRO-PG 06	13X1.90-RING
7	AMH-P769-PRO-PG 07	PressurevalueScrew
8	AMH-P769-PRO-PG 08	Spring
9	AMH-P769-PRO-PG 09	ValveRod
10	AMH-P769-PRO-PG 10	M6X14Bolt
11	AMH-P769-PRO-PG 11	ValveBall
12	AMH-P769-PRO-PG 12	Pressurevalue Case
13	AMH-P769-PRO-PG 13	ValveSeat
14	AMH-P769-PRO-PG 14	Pipe
15	AMH-P769-PRO-PG 15	15X1.90-RING
16	AMH-P769-PRO-PG 16	OutletChamber
17	AMH-P769-PRO-PG 17	M6X16Bolt
18	AMH-P769-PRO-PG 18	OutletPressureHose
19	AMH-P769-PRO-PG 19	OutletChamberDou- bleHole
20	AMH-P769-PRO-PG 20	ValveAss'y
21	AMH-P769-PRO-PG 21	M6X70Bolt
22	AMH-P769-PRO-PG 22	SutionPipe DoubleHole
23	AMH-P769-PRO-PG 23	Nut
24	AMH-P769-PRO-PG 24	SuctionPipe
25	AMH-P769-PRO-PG 25	Cylinder
26	AMH-P769-PRO-PG 26	CreaseSeat
27	AMH-P769-PRO-PG 27	ParkingSeat
28	AMH-P769-PRO-PG 28	V-Parking
29	AMH-P769-PRO-PG 29	CreaseSeat
30	AMH-P769-PRO-PG 30	reasePacking

S.N.	PART NO.	DESCRIPTION
31	AMH-P769-PRO-PG 31	AdjustingRing
32	AMH-P769-PRO-PG 32	FixedSeat
33	AMH-P769-PRO-PG 33	22X2.4 O-RING
34	AMH-P769-PRO-PG 34	18X28X8 OilSeal
35	AMH-P769-PRO-PG 35	Paster
36	AMH-P769-PRO-PG 36	Blot
37	AMH-P769-PRO-PG 37	176 Plunger
38	AMH-P769-PRO-PG 38	CylinderDoubleHole
39	AMH-P769-PRO-PG 39	SutionPipe
40	AMH-P769-PRO-PG 40	OilGlass
41	AMH-P769-PRO-PG 41	25X3.5 O-RING
42	AMH-P769-PRO-PG 42	Lid
43	AMH-P769-PRO-PG 43	60X3 O-RING
44	AMH-P769-PRO-PG 44	GrankCase
45	AMH-P769-PRO-PG 45	Bearing
46	AMH-P769-PRO-PG 46	GearShaft
47	AMH-P769-PRO-PG 47	6201 Bearing
48	AMH-P769-PRO-PG 48	Gasket
49	AMH-P769-PRO-PG 49	DrumCase
50	AMH-P769-PRO-PG 50	14X1.9 O-RING
51	AMH-P769-PRO-PG 51	Pipe
52	AMH-P769-PRO-PG 52	ClutchDrum
53	AMH-P769-PRO-PG 53	6200 Bearing
54	AMH-P769-PRO-PG 54	6203 Bearing
55	AMH-P769-PRO-PG 55	Gear
56	AMH-P769-PRO-PG 56	608 Bearing
57	AMH-P769-PRO-PG 57	Clip
58	AMH-P769-PRO-PG 58	Cylinder
59	AMH-P769-PRO-PG 59	9X1.9 O-RING
60	AMH-P769-PRO-PG 60	BlotM6*10

INSPECTION & MAINTENANCE

For safety use, make sure the machine is cleaned every three-months. Before working, make sure to inspect the filter and the nozzle, and ensure there is no impurity. After working, make sure there is no water in the pump and the hose.

If the machine needs to be repaired in the guarantee period, please return the machine to the shop. You need to provide the certificate of purchase in order to repair or get the substitute.

Before Packing, the machine should be cleaned, then use closed packaging, packaging should be firm. Store the machine in dry place.

For transportation safety. The machine should comply with ISTA.



Meaning of crossed - out wheeled dustbin:

Do not dispose of electrical machines as unsorted municipal waste, use separate collection facilities.

If electrical machines are disposed of in landfills or dumps, hazardous substances can leak into the groundwater and get into the food chain, damaging your health and well-being.

When replacing old machines with new ones, the retailer is legally obligated to take back your old machine for disposals at least free of charge.

Warranty Card

CUSTOMER COPY



Purchaser's Name & Address

Product Name

AMH-P769 PRO with GX35

Product Serial No.

Invoice / DN No.

Date of Delivery

Dealer's Office Seal

Dealer Sign _____

Customer Sign. _____

I/We accept the terms and conditions of Warranty as in the Warranty Card.

Warranty Card

DEALER'S COPY



Purchaser's Name & Address

Product Name

AMH-P769 PRO with GX35

Product Serial No.

Invoice / DN No.

Date of Delivery

Dealer's Office Seal

Dealer Sign _____

Customer Sign. _____

I/We accept the terms and conditions of Warranty as in the Warranty Card.

Warranty Card

COMPANY COPY



Purchaser's Name & Address

Product Name

AMH-P769 PRO with GX35

Product Serial No.

Invoice / DN No.

Date of Delivery

Dealer's Office Seal

Dealer Sign _____

Customer Sign. _____

I/We accept the terms and conditions of Warranty as in the Warranty Card.

1. **LIMITED WARRANTY PERIOD** : For a period of six months from the date of Sale / delivery of the product which ever is earlier. 2. **LIMITED WARRANTY OBLIGATION** : Replacement of defective part(s) by authorized dealer are free of charges. If found defective by reasons of defective material / poor workmanship, parts will be replaced and there will be no value re-imburement. 3. **TERMS & CONDITIONS** : a. Claims under warranty will be accepted on submission of Warranty Card duly filled and stamped by authorized dealer together with the original purchase document. : b. Shipping / transportation / Incidental charges incurred in replacing defective parts under warranty shall be borne by the purchaser.

WARRANTY null & void if

- (i) Lack of maintenance, (ii) Incorrect use of the machine or tampering, (iii) Use of non-genuine spare parts, (iv) Usage of acids, solvents, or any flammable materials, (v) Non-usage of filter water / clear water / soft water & using water above 40°C temperature, (vi) While using the pressure washers to draw water which is contaminated with dust & solvents (eg. paint thinners, gasoline, oil, etc.), (vii) Repair done by unauthorized service people, (viii) Those parts subject to wear & tear due to normal operations and plastic parts, rubber items etc, (ix) Loose connections, faulty electrical fixtures & fluctuations in power supply.
4. Should any failure occur during or after the warranty period, customer does not have the right to interrupt payment / price discount.
5. Incidental or consequential damages like inconvenience commercial loss, loss of tie, mental agony etc.
6. Loss of any nature due to operation or non-operation is not covered under warranty.
7. All free service are at Dealer's service point only.
8. Warranty ceases if service is not done periodically.
9. The attached card should be completed and returned to Ratnagiri Impex Pvt. Ltd. for registration immediately after sale / delivery.
10. The warranty is void unless you register the warranty card with Ratnagiri Impex Pvt. Ltd.
11. The decision of Ratnagiri Impex Pvt. Ltd., in settling the warranty is final in all respects.
12. All disputes are subject to Bangalore Courts Jurisdiction

1. **LIMITED WARRANTY PERIOD** : For a period of six months from the date of Sale / delivery of the product which ever is earlier. 2. **LIMITED WARRANTY OBLIGATION** : Replacement of defective part(s) by authorized dealer are free of charges. If found defective by reasons of defective material / poor workmanship, parts will be replaced and there will be no value re-imburement. 3. **TERMS & CONDITIONS** : a. Claims under warranty will be accepted on submission of Warranty Card duly filled and stamped by authorized dealer together with the original purchase document. : b. Shipping / transportation / Incidental charges incurred in replacing defective parts under warranty shall be borne by the purchaser.

WARRANTY null & void if

- (i) Lack of maintenance, (ii) Incorrect use of the machine or tampering, (iii) Use of non-genuine spare parts, (iv) Usage of acids, solvents, or any flammable materials, (v) Non-usage of filter water / clear water / soft water & using water above 40°C temperature, (vi) While using the pressure washers to draw water which is contaminated with dust & solvents (eg. paint thinners, gasoline, oil, etc.), (vii) Repair done by unauthorized service people, (viii) Those parts subject to wear & tear due to normal operations and plastic parts, rubber items etc, (ix) Loose connections, faulty electrical fixtures & fluctuations in power supply.
4. Should any failure occur during or after the warranty period, customer does not have the right to interrupt payment / price discount.
5. Incidental or consequential damages like inconvenience commercial loss, loss of tie, mental agony etc.
6. Loss of any nature due to operation or non-operation is not covered under warranty.
7. All free service are at Dealer's service point only.
8. Warranty ceases if service is not done periodically.
9. The attached card should be completed and returned to Ratnagiri Impex Pvt. Ltd. for registration immediately after sale / delivery.
10. The warranty is void unless you register the warranty card with Ratnagiri Impex Pvt. Ltd.
11. The decision of Ratnagiri Impex Pvt. Ltd., in settling the warranty is final in all respects.
12. All disputes are subject to Bangalore Courts Jurisdiction

1. **LIMITED WARRANTY PERIOD** : For a period of six months from the date of Sale / delivery of the product which ever is earlier. 2. **LIMITED WARRANTY OBLIGATION** : Replacement of defective part(s) by authorized dealer are free of charges. If found defective by reasons of defective material / poor workmanship, parts will be replaced and there will be no value re-imburement. 3. **TERMS & CONDITIONS** : a. Claims under warranty will be accepted on submission of Warranty Card duly filled and stamped by authorized dealer together with the original purchase document. : b. Shipping / transportation / Incidental charges incurred in replacing defective parts under warranty shall be borne by the purchaser.

WARRANTY null & void if

- (i) Lack of maintenance, (ii) Incorrect use of the machine or tampering, (iii) Use of non-genuine spare parts, (iv) Usage of acids, solvents, or any flammable materials, (v) Non-usage of filter water / clear water / soft water & using water above 40°C temperature, (vi) While using the pressure washers to draw water which is contaminated with dust & solvents (eg. paint thinners, gasoline, oil, etc.), (vii) Repair done by unauthorized service people, (viii) Those parts subject to wear & tear due to normal operations and plastic parts, rubber items etc, (ix) Loose connections, faulty electrical fixtures & fluctuations in power supply.
4. Should any failure occur during or after the warranty period, customer does not have the right to interrupt payment / price discount.
5. Incidental or consequential damages like inconvenience commercial loss, loss of tie, mental agony etc.
6. Loss of any nature due to operation or non-operation is not covered under warranty.
7. All free service are at Dealer's service point only.
8. Warranty ceases if service is not done periodically.
9. The attached card should be completed and returned to Ratnagiri Impex Pvt. Ltd. for registration immediately after sale / delivery.
10. The warranty is void unless you register the warranty card with Ratnagiri Impex Pvt. Ltd.
11. The decision of Ratnagiri Impex Pvt. Ltd., in settling the warranty is final in all respects.
12. All disputes are subject to Bangalore Courts Jurisdiction



ratnagiri impex
BRINGING THE BEST TO THE FUTURE

1st Free Service Coupon

ISO 9001-2008
CERTIFIED COMPANY

FREE SERVICE COUPON (30 Days / 20 hrs (Which ever is earlier))

Model
AMH-P769 PRO with GX35

Serial Number

PDI Date

Purchase bill no.

Date

Service No.

Dealer's Office Seal

- Operations:
- Check and Test the Fuel Mixture.
 - Check and Clean the Air Filter
 - Check, Clean and Adjust the Spark plug
 - Check and Adjust the Carburetor Tuning
 - Check and Sharpen the cutting Tools
 - Start and Check the Noise, Vibration, Loosen / Fasteners etc.
 - Product familiarization on Usage
 - Routine maintenance and Storage

Dealer Signature.....

Customer Signature.....

Conditions: Operations listed have been performed to my entire satisfaction without any labour charges. Only consumables were charged.



agriculture | horticulture | sericulture | plantations | forestry | garden | health care

WARRANTY AND FREE SERVICE COUPON



ratnagiri impex
BRINGING THE BEST TO THE FUTURE

2nd Free Service Coupon

ISO 9001-2008
CERTIFIED COMPANY

FREE SERVICE COUPON (30 Days / 20 hrs (Which ever is earlier))

Model
AMH-P769 PRO with GX35

Serial Number

PDI Date

Purchase bill no.

Date

Service No.

Dealer's Office Seal

- Operations:
- Check and Test the Fuel Mixture.
 - Check and Clean the Air Filter
 - Check, Clean and Adjust the Spark plug
 - Check and Adjust the Carburetor Tuning
 - Check and Sharpen the cutting Tools
 - Start and Check the Noise, Vibration, Loosen / Fasteners etc.
 - Product familiarization on Usage
 - Routine maintenance and Storage

Dealer Signature.....

Customer Signature.....

Conditions: Operations listed have been performed to my entire satisfaction without any labour charges. Only consumables were charged.



agriculture | horticulture | sericulture | plantations | forestry | garden | health care

WARRANTY AND FREE SERVICE COUPON



ratnagiri impex
BRINGING THE BEST TO THE FUTURE

3rd Free Service Coupon

ISO 9001-2008
CERTIFIED COMPANY

FREE SERVICE COUPON (30 Days / 20 hrs (Which ever is earlier))

Model
AMH-P769 PRO with GX35

Serial Number

PDI Date

Purchase bill no.

Date

Service No.

Dealer's Office Seal

- Operations:
- Check and Test the Fuel Mixture.
 - Check and Clean the Air Filter
 - Check, Clean and Adjust the Spark plug
 - Check and Adjust the Carburetor Tuning
 - Check and Sharpen the cutting Tools
 - Start and Check the Noise, Vibration, Loosen / Fasteners etc.
 - Product familiarization on Usage
 - Routine maintenance and Storage

Dealer Signature.....

Customer Signature.....

Conditions: Operations listed have been performed to my entire satisfaction without any labour charges. Only consumables were charged.



agriculture | horticulture | sericulture | plantations | forestry | garden | health care

WARRANTY AND FREE SERVICE COUPON



Small Maintenance. Big Savings.



Small Maintenance. Big Savings.



Small Maintenance. Big Savings.

Do's & Don'ts

- Always read the instruction manual supplied along with the equipments and understand the correct installation and operating procedures before attempting to use the equipments.
- It is important to use the personal protection equipments such as head helmet with visor, ear defenders, goggles, safety gloves, cut resistant shoes, trousers and jackets while operating potentially dangerous machines.
- Avoid untrained persons using the equipments. Children must not be allowed to handle these equipments.
- Always use genuine spares and accessories in repairs and usage to derive maximum life of the equipments.
- Always keep the equipments in good working condition to minimise loss of output as well as to reduce the pollution and save the environment.
- Do not use the machine within range of persons unless they wear protective clothing.
- Do not operate the machine when fatigued or under the influence of alcohol or drugs.
- When the machine is running, please maintain a constant water supply. Without water circulation will damage the sealing rings of the machine.
- For more query kindly contact for our Service Center/Dealer/franchise

Agrimate Army For Pest Control

ANY WHERE - ANY TIME - ANY CROP

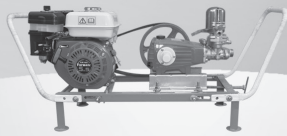

AGRIMATE[®]
Maximum Power - Super Economy

RATNAGIRI IMPEX PVT LTD
Annapurna House, #1/1G, 7th Cross, New Guddadahalli
Mysore Road, Bangalore-560 026
Customer Care: 1800 425 3036
email: info@ratnagiriimpex.com



Marketed by:
 **ratnagiri**[®]
impex
BRINGING YOU THE FUTURE... NOW

www.ratnagiriimpex.com

AN ISO 9001:2008 CERTIFIED COMPANY