

BCH 310 T Brushcutter



Documents

Engine

Transmission

Accessories

Head Tap&Go D.110

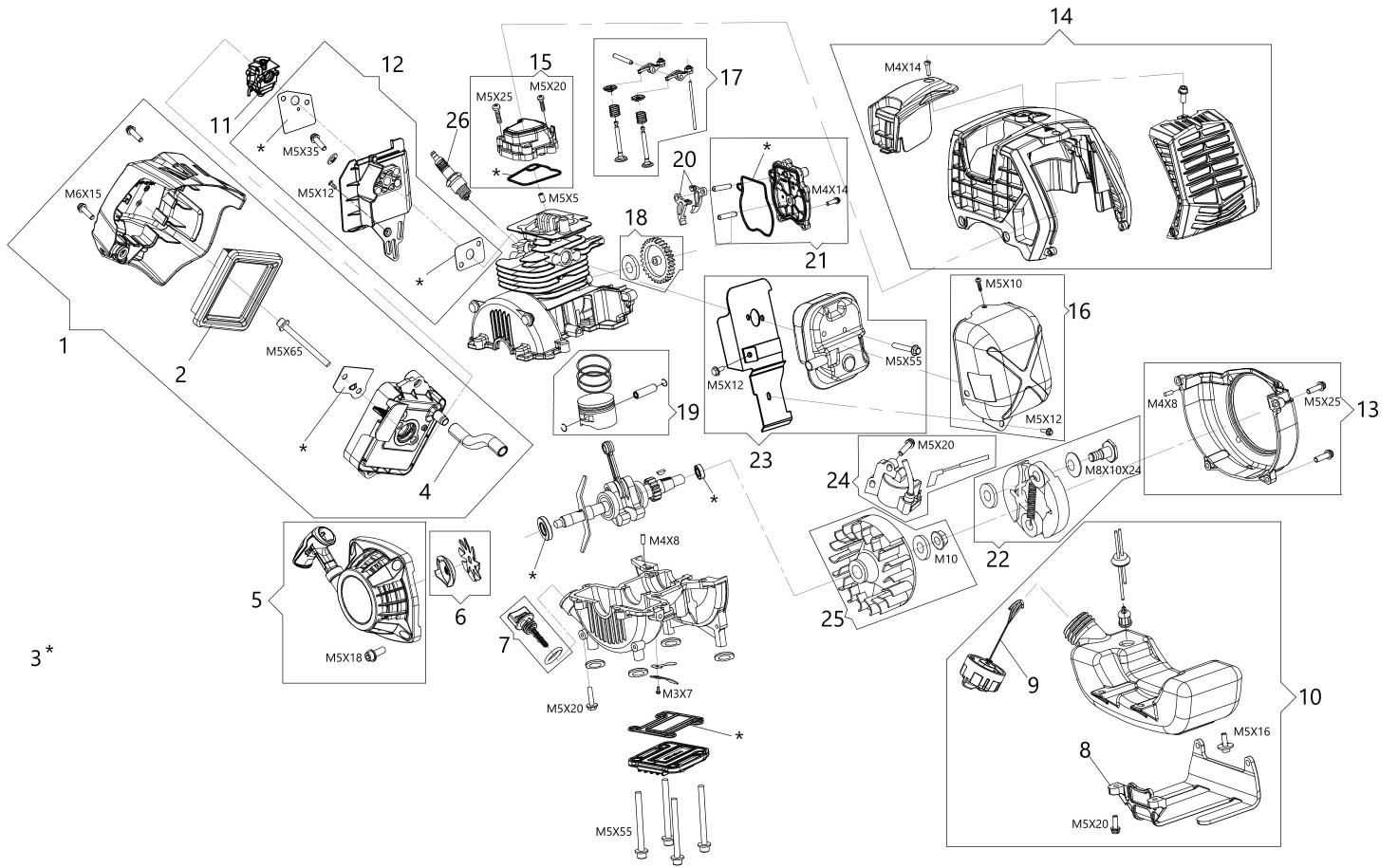

Illustration Engine

Ref.Nu	Qty	Part number	Description	Validity from	Validity till	Notes	Bulletin
1	1	GZ000170	Air filter kit				
2	1	GZ000102R	Air filter				
3	1	GZ000188	Gasket set				
4	1	GZ000106R	Oil line				
5	1	GZ000171	Starter assy				
6	1	GZ000172	Fan kit				
7	1	GZ000173	Oil cap assy				
8	1	GZ000165R	Stand				
9	1	GZ000164R	Tank cap				
10	1	GZ000186	Complete tank kit				
11	1	GZ000131R	Carburetor				
12	1	GZ000175	Thermal flange kit				
13	1	GZ000185	Conveyor group				
14	1	GZ000187	Cylinder cover set				
15	1	GZ000176	Cylinder cover set				
16	1	GZ000181	Exhaust cover kit				
17	1	GZ000177	Valves kit				
18	1	GZ000179	Cam kit				
19	1	GZ000174	Complete piston kit				
20	1	GZ000141R	Compensator				
21	1	GZ000178	Side cover kit				
22	1	GZ000184	Complete clutch				
23	1	GZ000180	Muffler assy				
24	1	GZ000183	Ignition coil				
25	1	GZ000182	Flywheel set				
26	1	L66152480	Spark plug				

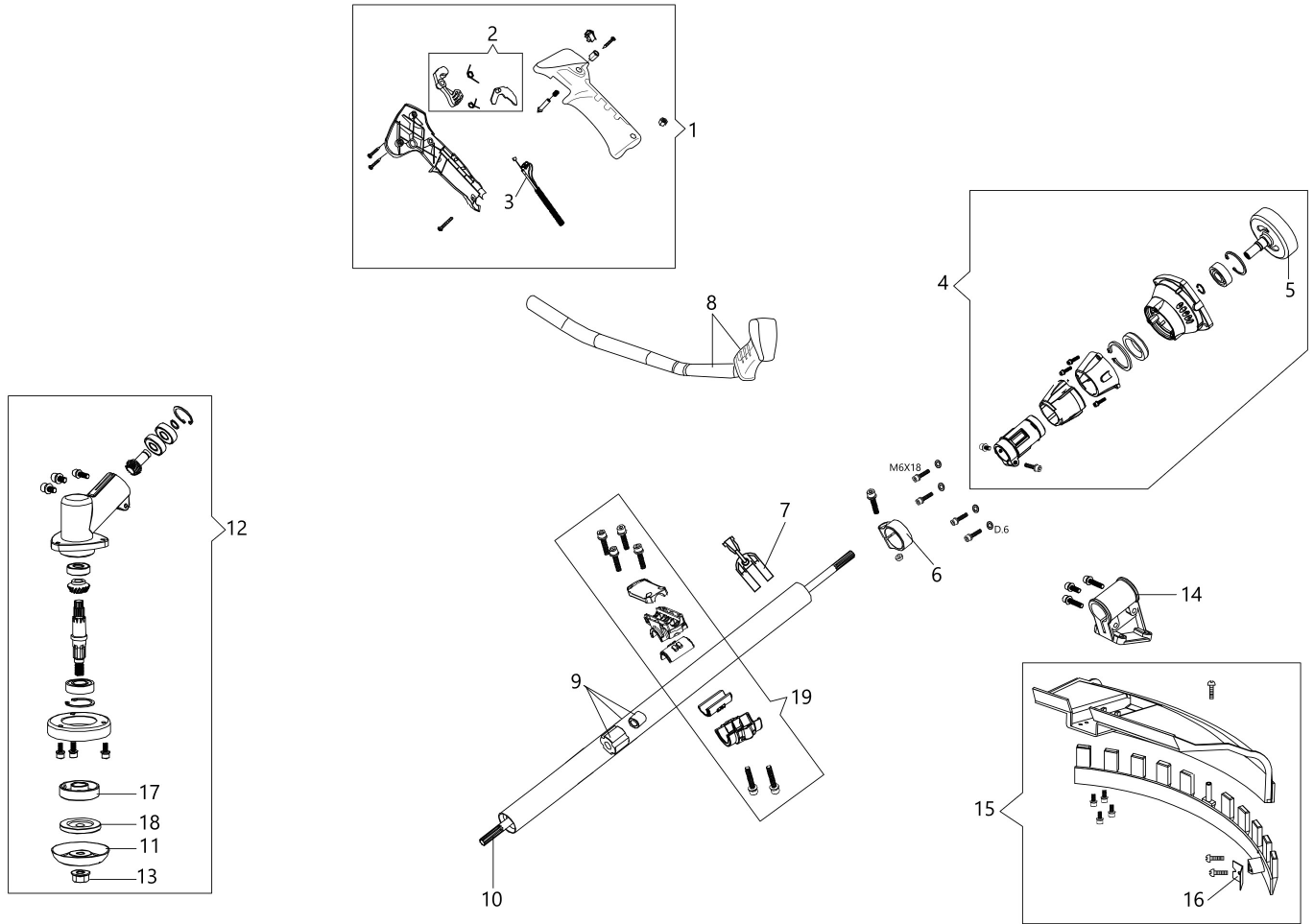

Illustration Transmission

Ref.Nu	Qty	Part number	Description	Validity from	Validity till	Notes	Bulletin
1	1	BF000059R	Complete handle				
2	1	BF000149R	Throttle lever assy				
3	1	BF000145R	Throttle cable				
4	1	61450327R	Starter case				
5	1	BF000011R	Clutch drum				
6	1	BF000012R	Band				
7	1	BF000048R	Band				
8	1	BF000058R	Handle and knob				
9	1	BF000014R	Tube Ø26				
10	1	BF000015R	Drive shaft				
11	1	BF000036R	Guard				
12	1	BF000144R	Bevel gear Ø26				
13	1	BF000007R	Nut				
14	1	BF000008R	Bracket				
15	1	BF000029R	Guard kit				
16	1	BF000009R	Blade				
17	1	BF000037R	Hub				
18	1	BF000038R	Flange				
19	1	61450328R	Complete clamp				

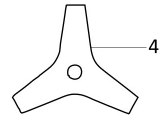
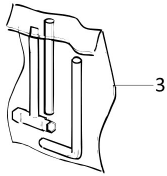
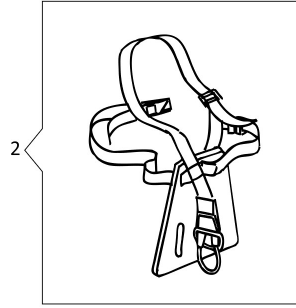
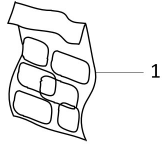

Illustration Accessories

Ref.Nu	Qty	Part number	Description	Validity from	Validity till	Notes	Bulletin
1	1	61550082R	Labels kit				
2	1	BF000020R	Harness				
3	1	61550026R	Tool kit				
4	1	4095673BR	3-tooth blade				

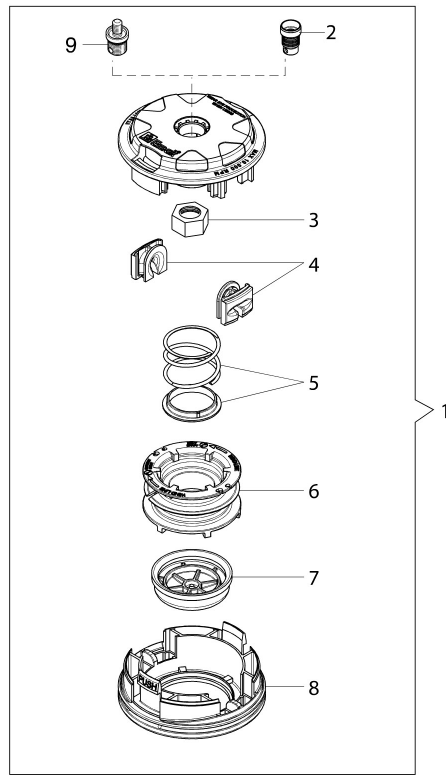

Illustration Head Tap&Go D.110

Ref.Nu	Qty	Part number	Description	Validity from	Validity till	Notes	Bulletin
1	1	61469100	Complete nylon head Ø 2,4				
2	1	63120041R	Insert				
3	1	63120040R	Nut				
4	2	61460049	Bushing				
5	1	63100018R	Kit spring				
6	1	61460023	Nylon spool				
7	1	61460022	Knob				
8	1	61460051	Lower cover				
9	1	63120042R	Insert (male)				